

**Custom Stand Alone Wiring Harness Guide
For The
LS1/LS2/LS4/LS6/LS7/LQ4/LQ9
GM Generation III and IV Engines**

COPYRIGHT NOTICE

Copyright protection is provided by the laws of the United States FBI to authors of "original works of authorship." This work is published under the authority of the copyright owner. The use of this notice is the responsibility of the copyright owner and does not require permission from, or registration with, the Copyright Office.

This notice informs the public that the work here in contained is protected by copyright, F-Bodies Inc is the copyright owner 2005 first publication year. Furthermore, in the event that a work is infringed, since this book carries a proper notice, the court will not give any weight to a defendant's interposition of an innocent infringement defense—that is, that he or she did not realize that the work was protected. An infringement defense will result in fines no less than \$250,000 United States dollars in damages that the copyright owner would otherwise receive, additionally, a minimal of 6 months jail time would ensue.

For this work was first published on or after March 1, 1989, use of this copyright notice is optional. All work contained in this manuscript is under copyright protection by the owner(s). You may not copy, distribute, store, change format or use in any fashion any of these works without express permission from the artist or writer even if no monetary gains are preformed.

Introduction:

These engines are known as the Generation 3 or Generation 4 models to GM. The previous generation 1 engines started production in 1955 and were made up into the late 1990's, a long and prosperous life cycle by any means especially considering all of the changes that the automobile market have went through. The Generation 2 started production in the 1993 model years and went up till 1997, not as long of a life but still a great type of engine to have. The Generation 3 engine was called the LS1, it came out in the 1997 Chevy Corvette. But what many people do not know is that the engine was first spawned onto a drawing board in early 1991, and was "okayed" by mid-year 1992, in turn giving the 5 engineers that designed it over 4 years to refine it into the engine that we know today.

The engine shares almost nothing with the previous years of the small block Chevy engines, other than the same 4.40" cylinder bore spacing, the same connecting rod bearings, a simplistic design, compact size, and an ability to produce an extremely high output.

The LS1 that came out in the 1997 Corvette was rated at 345 horsepower @ 5,600 RPMs with 350 lbs-ft of torque @ 4,400 RPMs. The engine was so successful that GM then installed it in the Camaro/Firebird Twins (F-Bodies) in 1998-2002 and had two ratings 305 horsepower and 320 horsepower. Then GM not letting a good thing go to waste came out with the Corvette Z06 LS6 engine in 2001 producing 385 horsepower. In 2004 the GTO came out with an LS1 engine rated at 350 horsepower. In 2005 GM came out with a LS2 engine that was rated at 400 horsepower and this engine was dropped into both the Corvette and the GTO. The LS4 came out in 2006 and was rated at 303 horsepower and was installed into the SS Impala the Pontiac Grand Prix and the SS Monte Carlo. Finally GM made the mother of all naturally aspirated factory engines for the 2006 Z06 Corvette putting out 505 horsepower and called it the LS7. Generally this book is going to stick to the LS1/LS6/LS2 engines because of their popularity.

The LS1 and LS6 are considered to be 350 engines, however, they are not really 350 cubic inches it is in fact 346 cubic inches (5.7 liter) which uses a 3.90" bore and a 3.62" stroke to give the engine some more torque in the bottom end. Compare those numbers to the generation 1's and generation 2's 350 cubic inch engines which have a 4.00" bore and a 3.48" stroke. The LS2 engines use a 4.00" bore and 3.62" stroke to make its 6.0 liters.

Here are some of GM's Specs for their engines.

LS1 Tech Specs

Block Part Number:	12561166
Block Type:	Cast aluminum with 6-bolt, cross-bolted main caps
Bore x stroke (in)	3.90 x 3.62 (99 x 92 mm)
Camshaft duration (@.050 in)	200 degree Intake / 203 degree exhaust
Camshaft lift (in):	.500 intake / .500 exhaust
Camshaft Part Number:	12561721
Camshaft type:	Hydraulic roller
Compression ratio:	10.26:1
Connecting Rod Part Number:	12568734
Connecting rods Type:	Powdered metal steel
Crankshaft Part Number:	89017522
Crankshaft Type:	Nodular iron
Cylinder head Part Number:	12559855
Cylinder head Type:	Aluminum, symmetrical port
Displacement (cu in):	346 (5.7L)
Engine Name:	LS1 5.7L:
Engine type:	LS Series small-block V-8
Maximum rpm:	6000 PCM Limited

LS2 Tech Specs

Block Part Number:	12568950
Block Type:	Cast aluminum with 6-bolt, cross-bolted main caps
Bore x stroke (in):	4.00 x 3.62 (101.6 x 92 mm)
Camshaft duration (@.050 in):	200 degree Intake / 203 degree exhaust
Camshaft lift (in):	500 Intake / .500 exhaust
Camshaft Part Number:	12574519
Camshaft type:	Hydraulic roller
Compression ratio:	10.9:1
Connecting Rod Part Number:	12577583
Connecting rods Type:	Powdered metal steel
Crankshaft Part Number:	12570249
Crankshaft Type:	Nodular iron
Cylinder head Part Number:	12564825
Cylinder head Type:	Aluminum, symmetrical port
Displacement (cu in):	364 (6.0L)
Engine Name:	LS2 6.0L:
Engine type:	LS Series small-block V-8
Maximum rpm:	6000 PCM Limited

LS6 Tech Specs

Block Part Number:	12561166
Block Type:	Cast aluminum with 6-bolt, cross-bolted main caps

Bore x stroke (in): 3.90 x 3.62 (99 x 92 mm)
Camshaft duration (@.050 in): 204 degree intake / 211 degree exhaust
Camshaft lift (in): .525 intake / .525 exhaust
Camshaft Part Number: 12565308
Camshaft type: Hydraulic roller
Compression ratio: 10.5:1
Connecting Rod Part Number: 12577583
Connecting rods Type: Powdered metal steel
Crankshaft Part Number: 12583565
Crankshaft Type: Nodular Iron
Cylinder head Part Number: 12564825
Cylinder head Type: Aluminum, symmetrical port
Displacement (cu in): 346 (5.7L)
Engine Name: LS6 5.7L:
Engine type: LS Series small-block V-8
Maximum rpm: 6500 PCM Limited

LQ9 Tech Specs

Block Part Number: 12572808
Block Type: Cast iron with 6-bolt, cross-bolted main caps
Bore x stroke (mm) 101.6 x 92
Camshaft duration (@.050 in): 196 degree intake / 201 degree exhaust
Camshaft lift (in): .467 intake / .479 exhaust
Camshaft Part Number: 12561721
Camshaft type: Hydraulic roller
Compression ratio: 10:1
Connecting Rod Part Number: 12567583
Connecting rods Type: Powdered metal steel
Crankshaft Part Number: 12569768
Crankshaft Type: Nodular iron
Cylinder head Part Number: 12562319
Cylinder head Type: Aluminum, symmetrical port
Displacement (cu in): 364 (6.0L)
Engine Name: LQ9 6.0L:
Engine type: LS Series V-8
Maximum rpm: 5600 PCM Limited

LS7 Tech Specs

Block Part Number: 17802854
Block Type: Cast aluminum w/6-bolt steel main bearing caps
Bore x Stroke (in): 4.125 x 4.00 (104.8 mm x 101.6 mm)
Camshaft Duration: 211 degree intake / 230 degree exhaust
Camshaft lift (in): .591" (15 mm) Intake and Exhaust
Camshaft Part Number: 12571251
Camshaft type: Hydraulic roller
Compression ratio: 11.0:1

Connecting Rod Part Number:	12586258):
Connecting rods Type:	Forged titanium
Crankshaft Part Number:	12568819
Crankshaft Type:	Forged steel
Cylinder head Part Number:	12578450
Cylinder head Type:	CNC Ported LS7 specific pattern 70 cc CNC combustion chambers
Displacement (cu in):	427 (7.0L)
Engine Name:	LS7:
Engine type:	Cam-in-block 90-degree V8
Maximum rpm:	7000 PCM Limited

First, before we jump into working on one of these engines, we have to learn the basics of the LS series of engines.

Block Design



The Block is an all aluminum casting (Made from T5 aluminum), it has cast iron cylinder sleeves with a deep skirt design this accompanied with the extended oil pan rails greatly improve the block's rigidity and stiffness. The five main crankshaft caps are recessed up between the oil pan rails to prevent crankshaft flex. Also since they are recessed it enabled GM to use 6 main bolts for the caps instead of using a standard of 2. Each cap has 4 vertical studs that point up toward the lifter valley and two that go horizontally through the side of the block to minimize block distortion, noise, and vibrations.

Crankshaft

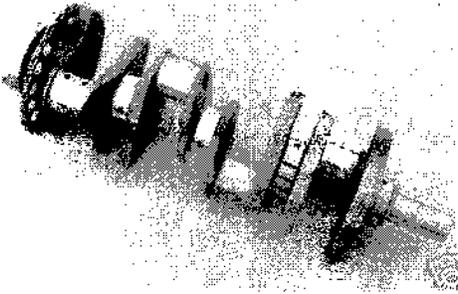

The Crankshaft is a Nodular Iron unit that GM has Shot Gun drilled to decrease it's weight. The crank is designed to handle up to 800 horsepower, however it can be used in applications up to and exceeding 1000 horsepower. (Not recommended but it can be done with the right block prep also known as blue printing.) It has a 24 tooth reluctor wheel at it's rear, the LS2 engine uses the same crank but with a 58 tooth wheel both are for the PCM's crankshaft position sensor. The crank has a Rod diameter of 2.100" and a Main diameter of 2.559".

Pistons



The Pistons are a set of cast aluminum pieces with a completely flat top design (not even a valve relieve) that can handle up to 550 horsepower. In 2004+ years there is an anti heat coating that was added to them so that they can handle about 600 horsepower and have a reduced friction.

Connecting Rods



The Connecting Rods are a Forged powder metal that use a set of bolts that screw right into the rod's fork end. (not shown in the picture) the connecting rods can take up to 600 horsepower. But the bolts are nowhere near that, they are the first to break, so when you get a set of Is1 connecting rods, replace the bolts with a high performance set.

NOTE: The Rods the Pistons and the Crankshaft are all balanced from the factory for increased engine life, less vibration, and more horsepower.

Cylinder Heads

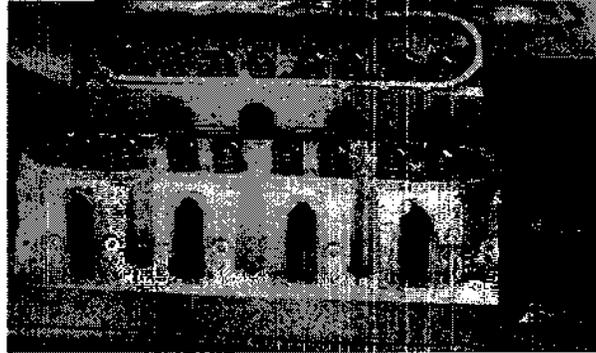

The LS1 heads are cast out of a T6 aluminum at only 15 degrees compared to the generation 1's and 2's 23 degree cylinder heads. The heads use four bolts per cylinder for attachment to the block. On their intake side (bottom of picture) they use all evenly spaced symmetrical style ports that have a "cathedral" shape to them. The exhaust side ports (top of picture) use a standard shaped port, an oval shape for the LS1 and truck heads and a D shaped port for the Corvette. The heads have a heart shaped combustion chamber with two valves per cylinder that have the spark plug set right in the center of them. The Heads incorporate a large squish area combined with their 15 degree rake create a lot of turbulence inside of the cylinders for more improved combustion and less quenching of the fuel and the air (quenching is when the fuel separates from the air condensing onto solid objects like pistons, rings, valves, cylinder walls, heads, ect.)

Camshafts

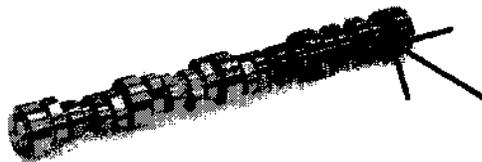

The camshaft is a roller hydraulic unit that uses very large bearing journals to help support the high pressure from the valve springs pushing onto it. The camshaft is also shot gun drilled from the factory to reduce rotating weight. Also take notice that there is no fuel pump lobe nor is there any distributor drive gear, but there is a thin ring going around the rear (arrow) for the PCM's camshaft position sensor.

Here are some Camshaft GM part numbers (Factory Stock)

GM Part #	Valve Lift (Int/Exh)	Dur.@.050" Lift	Centerline (Int/Exh)	Lobe Sep
12554710**	.472/.479	202/210	121/113	117
12560964	.472/.479	202/210	121/113	117
12560965	.500/.500	201/212	122/117	119.5
12560968	.500/500	201/212	119/112	115.5
12561721	.467/479	199/210	115/117	116

** This Camshaft uses a different reluctor ring for the camshaft position sensor compared to the rest of the LS camshafts.

Lifters

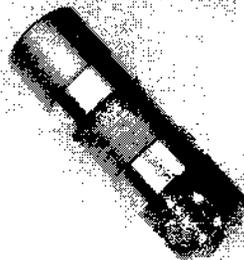

The LS1's valve lifters are the standard roller design but are a different size than the generation 1's and 2's roller lifters. (the engine uses 16 roller lifters)

Push Rods

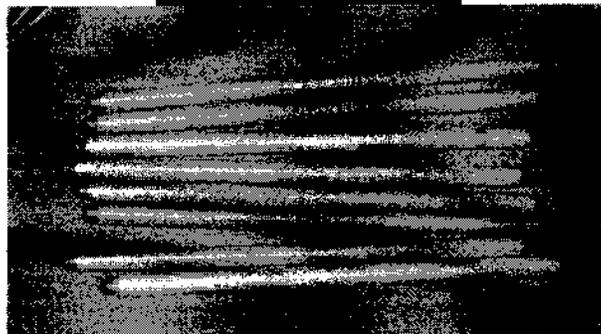

The LS1's push rods are a standard steel rod that is 7.400" long
(Only 8 are shown but the engines use 16 of them)

Lifter Guides



The Lifter guides are made from a composite (plastic) material to keep the lifters aligned on the camshaft to prevent them from spinning around and destroying the lifters themselves and destroying the cam lobes. Each guide houses four lifters and has a single bolt in the center that holds it to the block. So each engine has four lifter guides total.

Rocker Arms

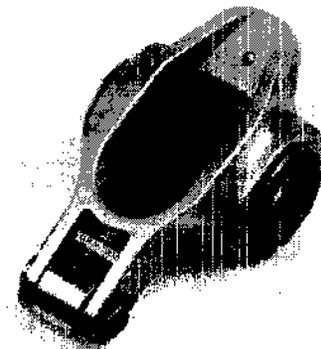

The rocker arms are cast steel in some engines or stamped steel in other depending on year and engine type that you have. For instance the LS7 had roller tipped rocker arms to decrease valve train temps, decrease valve stem and guide wear, and to increase horsepower like what is shown in the picture above. (16 for an engine)

Rocker Arm Stands

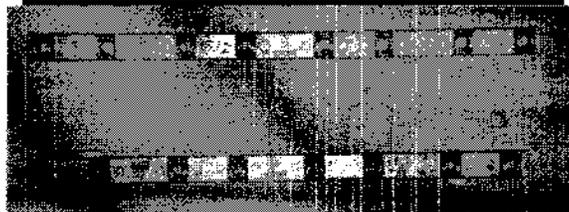

Each engine has two rocker arm stands that support the rockers and keep them aligned with the rest of the valve train; all while strengthen the cylinder head from warping. (Two for an engine)

Intake Manifold/Throttle Body/Coil Packs

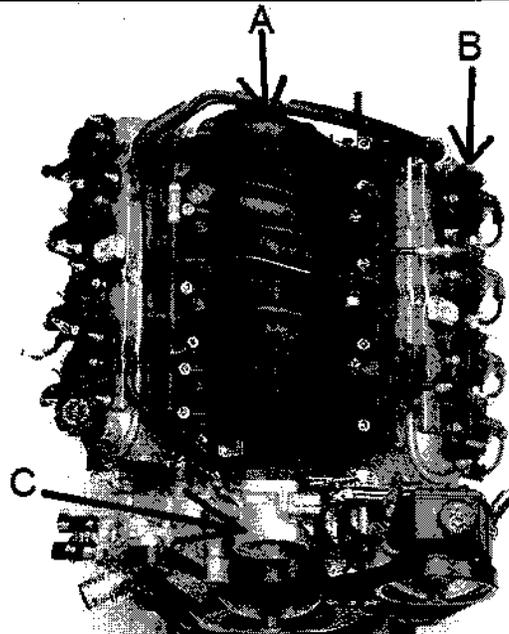

The intake manifold (A in the picture) is made from a composite material (plastic) it is where the air coming through the throttle body gets distributed to the eight cylinders of the engine. It is also where the fuel injector nozzles plug into to spray the fuel into the air charge entering the engine. The throttle Body (C in the picture) is a large valve that opens and closes compared to how much air is required for the engine. Also from this view we can see the Coil packs (B in the picture) there are eight of these, one for each cylinder of the engine. Their job is to convert the primary voltage (low voltage) into secondary voltage (high voltage 40,000+ volts) so that the electrical current can jump the gap in the spark plugs to ignite the fuel and air mixture inside the cylinders. The firing order has also been changed to 1-8-7-2-6-5-4-3.

Oil Pans

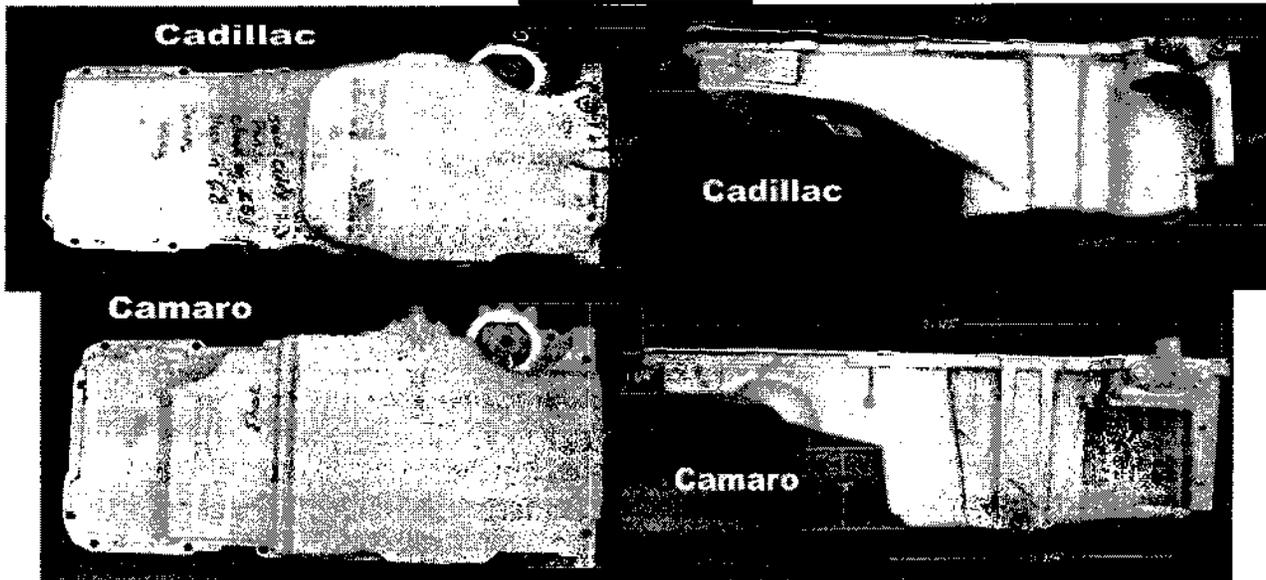

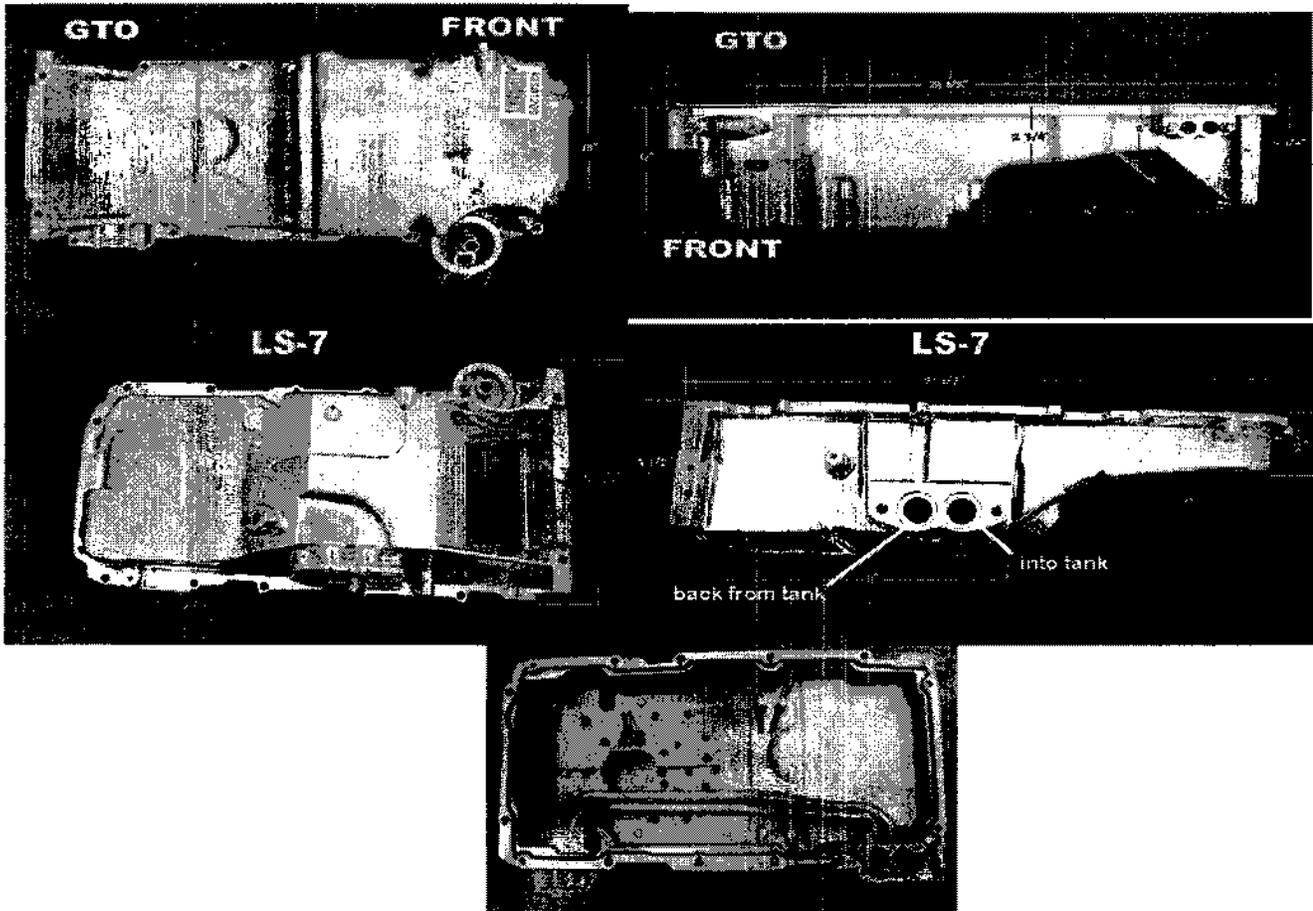

There are a couple different shaped oil pans that were used on the engines all of them did the same job, to store the oil so that it can be pumped throughout the engine. Except for one, the LS7's oil pan was called a dry sump and its job was to catch the oil coming out of the engine so that it can be pumped into a separate oil storage container then it will be repumped throughout the engine. On the picture that you can see the inside it is a Camaro/Firebird pan, you can see the oil baffling which is used to keep the oil from splashing around, and you can also see some of the oil pump plumbing. (the two metal tubes)

Oil Pump

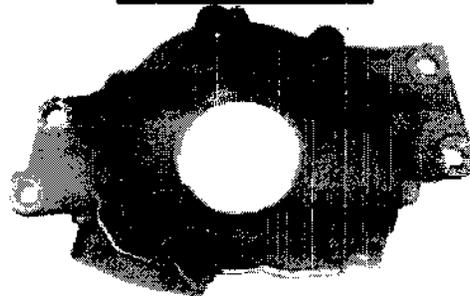

The oil pump is a rotor design instead of the old style gear design that we are all used to seeing. The rotor design is capable of a higher pressure, more flow, less aeration, and has a higher RPM limit. The rotor designed pump is run off of the front of the crankshaft and its design came from a transmission front pump where it has been used from years with little failure.

Motor Mounts and Physical Engine

LS1 - STREET ROD STYLE (LOW)

(2) Idlers Passenger Side - (1) Idler Driver Side
Small 10 O'Clock Alternator
NO Power Steering Pump

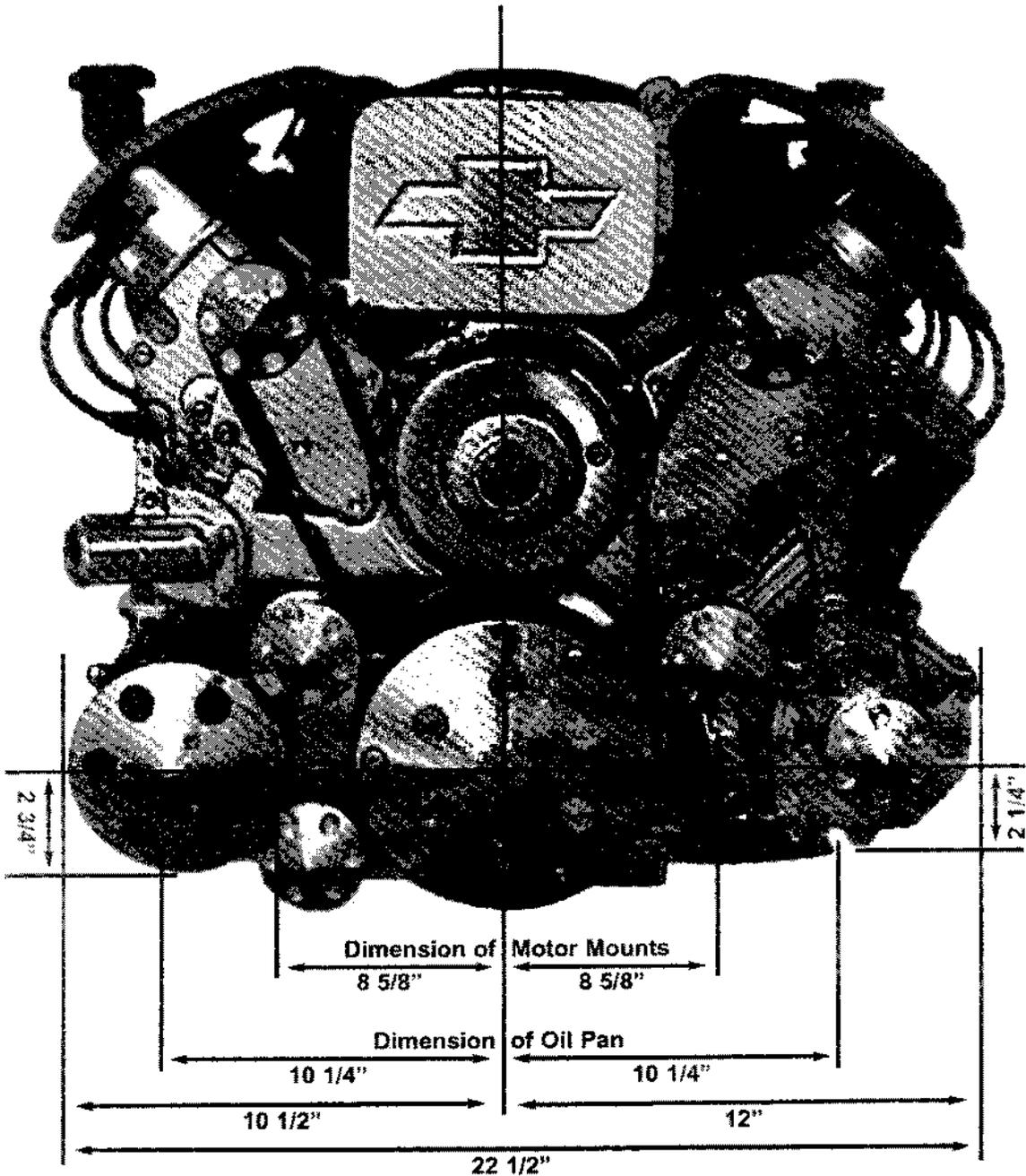

LS1 - VETTE/CAMARO

Driver Side - Side View

Small 10 O'Clock Alternator w/ 8 O'Clock Adapter
Type LSVC Power Steering Pump

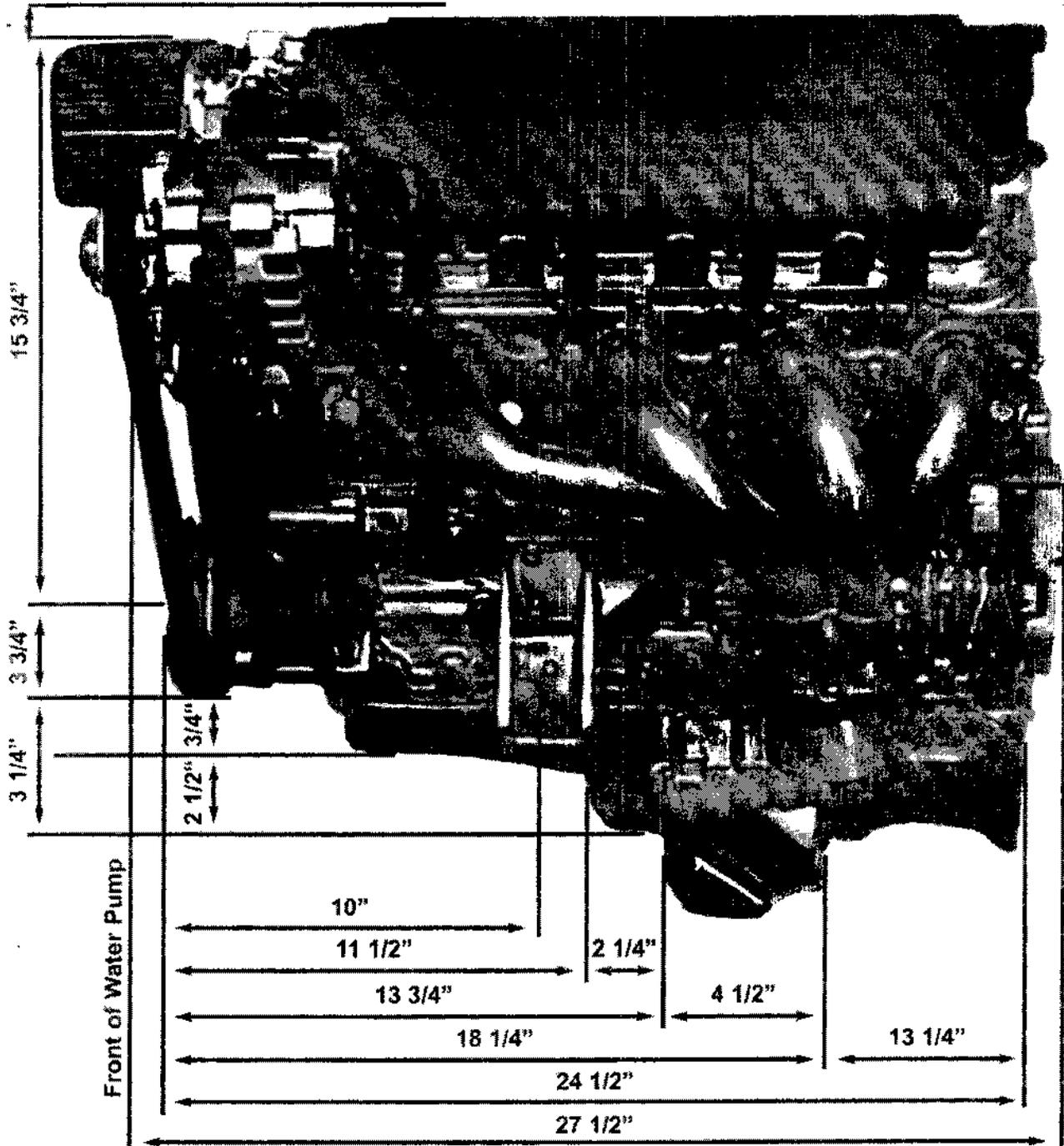

Physical Measurements of a 4L60E

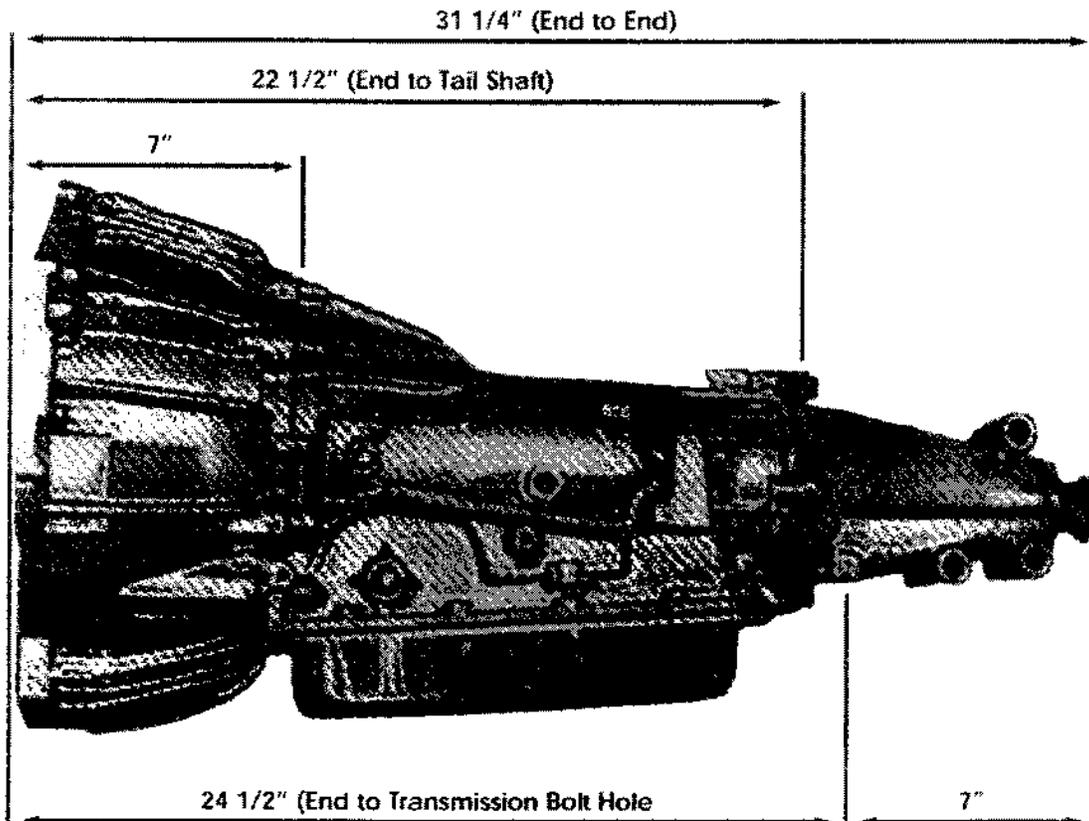

Flexplates / Flywheels

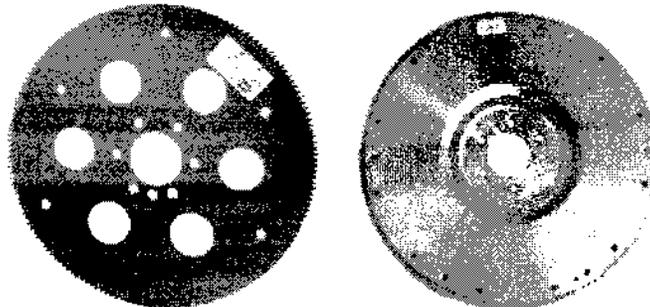

GM makes a stock flexplate to hook a 4L60E with it's 300mm bolt pattern to the LS1 it is GM part number is 12563136 and it has a bell or a dished shape to it. GM also makes a flexplate to hook up a 4L60, TH700-R4, TH350, 4L80, 4L80E, and a TH400 to the LS1 and that part number is 12551367, this flexplate has a flat appearance and it's bolt pattern is 298mm. Also be sure that you use a collar on the torque converter to support it, it is part number HUP-HP3795 from summit racing made by Hughes Performance

There are two flywheels that GM makes for the LS1, part number 12561680 is for if you want to put an old 3 or 4 speed behind it, but if you are using an old non OEM manual transmission then you are going to have to compensate for the .400" crankshaft offset with this special pilot bushing GM part number 12557583. if you are going to be using a 6 speed transmission then you will need a flywheel part number of 12562765.

Now for the Engine's sensors and actuators

KNOCK SENSOR

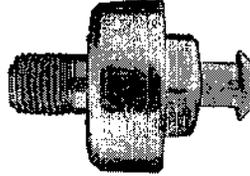

Knock Sensor: The knock sensor detects vibrations that are a tell tail sign of detonation, when it "sees" this detonation it communicates with the PCM to remove some ignition timing up to 20 degrees of total timing. Some reasons that the engine is detonating is; too low of octane in the fuel, too high of engine temperature, too high of an engine load, or the initial distributor timing was far too advance for the engine. The knock sensor can normally be under the intake manifold screwed into the block. Also your engine will have two of these sensors, they both operate the same way, both are under the intake manifold one right in front of each other.

MAT



MANIFOLD AIR TEMPERATURE SENSOR: The Manifold Air Temperature Sensor is also called a MAT or sometimes the Air Charge Temperature Sensor, it is located threaded into a boss in the intake tubing after the air filter. This sensor communicates with the PCM any changes in intake air temperatures so that the computer can lean out or for enrichment to the fuel to air ratio.

TPS

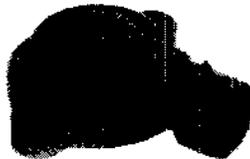

THROTTLE POSITION SENSOR: The TPS is a type of load sensor that informs the PCM where the throttle blade is located at (how far open or how far closed it is) The TPS tells the PCM this by a voltage drop method, it has a 3-wire connector and is moved by a small arm on the side of the throttle body, the TPS is held to the side of the throttle body by two screws. Basically the TPS is a variable resistor that sends about a .54-volt (+/- .08 volts) signal to the ECM at idle and a 5-volt signal at wide-open throttle, and anywhere in-between depending on the location of the throttle blades.

IAC

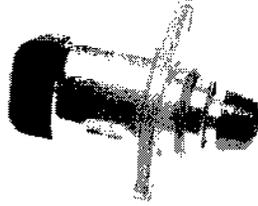

IDLE AIR CONTROL: This is actually not a sensor at all, it is actually a small stepper motor that is mounted on the throttle body. It works by moving the small point (or needle) back and forth onto a bypass port varying the amount of air entering the engine to maintain a smooth engine idle speed whenever the throttle blades are in their closed position. This is a non adjustable unit because in the PCM has a set parameter for the engine's idle speed. (unless you change it through a PCM editor)

CTS



COOLANT TEMPERATURE SENSOR: This sensor is mounted into one of the cylinder heads tapping into the engine's circulating coolant. It sends the PCM important information on the engine's internal water temperature so that the PCM can adjust for the right fuel to air ratio.

FUEL INJECTORS

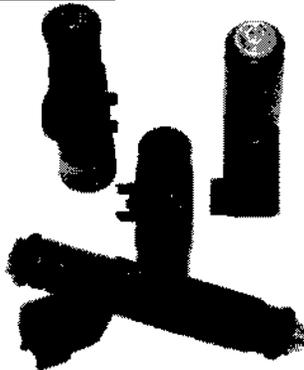

FUEL INJECTORS: The stock fuel injectors had two different sizes available, depending on the year of your engine 1997, 1998, 2001, 2002, 2003, 2004 are all 28# injectors While 1999 and 2000 are only 26# injectors from the factory. A fuel injector is nothing more than a high-speed valve for gasoline. An engine computer or controller is used to control the fuel injector. Contrary to popular belief, this is not done by sending power to the injector. Fuel injectors are normally fed power whenever the ignition key is on. The computer controls the negative, or groundside, of the circuit. When the computer provides the injector with a ground, the circuit is completed and current is allowed to flow through the injector. This energizes an electromagnetic coil inside the injector, which pulls a sealing mechanism called the pintle away from its seat. This makes it possible for fuel to flow through the injector and into the engine. When the computer removes the electrical ground to the injector, the electromagnetic coil becomes demagnetized and a spring forces the pintle shut to cut off the fuel flow.

Fuel Pressure Regulator

Fuel Pressure Regulator: What the fuel pressure regulator does is it simply makes a restriction in the fuel system, the more restricted it is, the more PSI the fuel rail will have at the fuel injectors. This device can be found in two places depending on the year you are working with, in the early years it was located on the fuel rail like we normally see it in most cars, these systems used two fuel lines on the fuel rail one a feed and one a return to the tank, the later years use what is called a dead head or dead end system which has the fuel pressure regulator in the fuel tank and only had a feed fuel line running up to the fuel rail. LS1 stock fuel systems like 50-60 PSI to run.

Fuel Injector rails

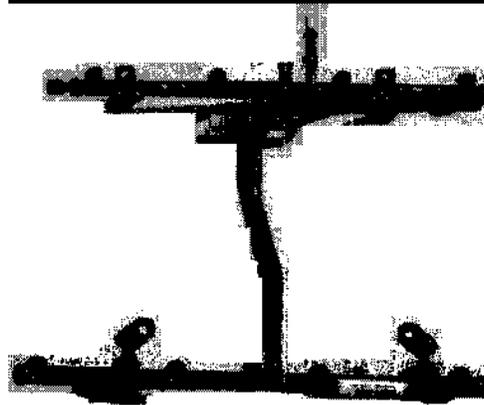

Fuel Injector rails: Above is a single line fuel rail (so the regulator is in the fuel tank) All of the engines same fuel injector rails except for the rails with the regulators mounted onto them like I stated before.

OXYGEN SENSOR



OXYGEN SENSOR: There are four oxygen sensors, two can be found threaded into the exhaust manifolds the other two are just behind the catalytic converters. The Oxygen sensors are heated which means that they use 12 volts to heat up their tips to about 600 degrees or more so that they can function. It measures the amount of oxygen content in the exhaust of the engine by letting the oxygen molecules through the slats of the tip and reacting with a rare earth metal which then produces a small voltage signal. The PCM requires this sensor so that it can go into a mode called "closed loop" while the computer is working in this mode it is constantly adjusting the air fuel ratio so that the engine can produce maximum horsepower with minimum harmful emissions. The voltages that this sensor is very small, (between .1 volt for a lean condition and 1 volt for a rich condition) the best reading that you can get from this sensor is .450 volts, that will give you the best gas mileage, the best horsepower, and the best torque available from your engine.

MAF SENSOR



MASS AIR FLOW SENSOR: The MAF sensor measures the amount of air going into the engine. GM's LS engines use what is called a heated wire MAF or a Hot wire MAF, which means that it heats a wire and uses the air that flows past it to cool it off, now of course the more air that goes past them, the cooler the wire will get. The cooler the wire gets, the less resistance the wires have, so the ECM uses the amount of resistance and the amount of amps need to keep the wire at a certain temp into a math calculation to figure out how many grams per second of air the engine is taking in. This sensor must of course be mounted between the throttle body and the air cleaner in order for the correct readings but no farther than 15 inches away from the throttle body, placing it any further away will make the readings inaccurate.

EGR



EGR: The EGR is only used on the early years of the LS engines, it is not used anymore. EGR stands for Exhaust Gas Recirculation valve. It is a very simple device in how it's operation works... EGR works by recirculating a portion of an engine's exhaust gas back to the engine cylinders. Intermixing the incoming air with recirculated exhaust gas dilutes the mix with inert gas, lowering the peak combustion temperatures and reducing the amount of excess oxygen. Because NOx formation progresses much faster at high temperatures, EGR serves to limit the generation of NOx. NOx is primarily formed due to the presence of oxygen and high temperatures along with nitrogen. The PCM controls the EGR digitally with square waves and uses a the engines other sensors to check to make sure that it is working and flowing correctly.

Vehicle Speed Sensor



Vehicle Speed Sensor: Also called the VSS, this sensor sends a pulsed voltage signal to the PCM. The PCM then converts the number of pulses into miles per hour. Then the PCM will control mainly the Torque Converter Lock up solenoid, the automatic transmission if equipped, the speedometer and the cruise control. It can be found where the speedometer gear would be inside the extension housing of the transmission.

PCM

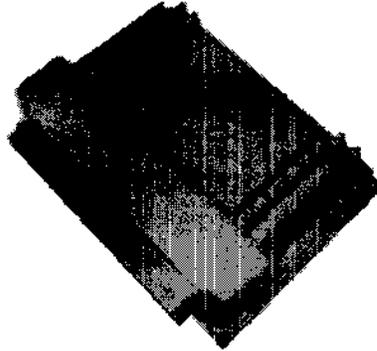

PCM: The PCM can be also called the computer or the “brain” of the system. I could go on and on about how the PCM works and what it does, but that would be a lot of useless information for what you or anyone else would need to know to work on an LS engine. Basically in a nutshell, the PCM takes in all of the information from all of the sensors and computes all the outputs for all the actuators. There is no removable PROM or mem-cal chip. The PCM is weather proof so it is designed to go under the hood. ***NOTE: DUE TO THE LOW VOLTAGES THAT THE PCM WORKS WITH, YOU MUST SOLDER ALL CONNECTIONS AND THEN USE SOME SHRINK TUBING. NOT THE CRIMP OR BUTT CONNECTORS.***

OBD 2 Connector

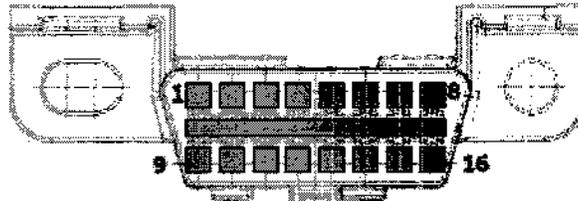

OBD 2 CONNECTOR: (OBD stands for On Board Diagnostic) Also known as the Diagnostic connector, think of this as your way to interface with the PCM.

Neutral/Park/Clutch Safety Switch

AUTOMATIC TRANSMISSION

MANUAL TRANSMISSION



NEUTRAL/PARK/CLUTCH SAFTY SWITCH: This switch does exactly what the name sounds like, if the transmission is not in park or neutral then the switch is not grounded and the PCM will not let the car start and this switch is found on the shifter itself. If you have a manual transmission, then must depress down the clutch in order to start the car, but this switch can be found under the dash resting against the clutch pedal.

MAP

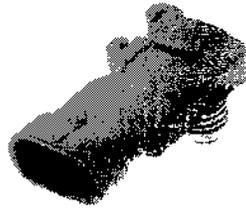

MAP: MAP stands for Manifold Absolute Pressure, this sensor is a load sensor like the MAF sensor or the TPS, but it does not actually measure the air traveling into the engine, but it instead measures the amount of manifold vacuum, the more open the throttle is, the less vacuum there is in the manifold.

Camshaft Position sensor



Camshaft Position Sensor: This sensor is mounted in a vertical position behind the intake manifold, it lets the PCM know when to fire the spark plugs and the fuel injectors in relation to when the intake and exhaust valves are open or closed.

Crankshaft Position sensor



Crankshaft Position Sensor: This sensor is mounted in a horizontal position on the side of the block, it lets the PCM know when to fire the spark plugs and the fuel injectors in relation to where the piston is in it's stroke.

There are Three Modes that your PCM works in:

OPEN LOOP

When the engine is first started, the PCM goes into "Open Loop" configuration. In Open loop the PCM calculates the fuel to air ratio using only the MAP/MAF and the coolant temp sensors. The PCM will continue to operate like this until these three criteria are met: O2 sensor is over 600 degrees, the coolant is over 100 degrees, and a certain amount of time has passed.

CLOSED LOOP

Once all of the three criteria are met as listed in "Open Loop" the system goes into Closed loop mode, once it is in "Closed Loop" the PCM will continue to vary the fuel to air mixture until it gets the 14.7 to 1 which is the best performance and best emissions.

LIMP MODE

If there is a extreme problem and the PCM picks up on it, it will send the fuel injection and spark timing into what is called "Limp Mode" which runs the engine off of a set value so that you can get home.

Here is a list of more common Trouble Codes

P0101	Mass or Volume Air Flow Circuit Range/Performance Problem
P0102	Mass or Volume Air Flow Circuit Low Input
P0103	Mass or Volume Air Flow Circuit High Input
P0107	Manifold Absolute Pressure/Barometric Pressure Circuit Low Input
P0108	Manifold Absolute Pressure/Barometric Pressure Circuit High Input
P0112	Intake Air Temperature Circuit Low Input
P0113	Intake Air Temperature Circuit High Input
P0117	Engine Coolant Temperature Circuit Low Input
P0118	Engine Coolant Temperature Circuit High Input
P0121	Throttle Position Sensor/Switch A Circuit Range/Performance Problem
P0122	Throttle Position Sensor/Switch A Circuit Low Input
P0123	Throttle Position Sensor/Switch A Circuit High Input
P0125	Insufficient Coolant Temperature for Closed Loop Fuel Control; ECT Excessive Time to Closed Loop Fuel Control
P0131	O2 Sensor Circuit Low Voltage (Bank 1 Sensor 1)
P0132	O2 Sensor Circuit High Voltage (Bank 1 Sensor 1)
P0133	O2 Sensor Circuit Slow Response (Bank 1 Sensor 1)
P0134	O2 Sensor Circuit No Activity Detected (Bank 1 Sensor 1)
P0135	O2 Sensor Heater Circuit Malfunction (Bank 1 Sensor 1)
P0151	O2 Sensor Circuit Low Voltage (Bank 2 Sensor 1)
P0152	O2 Sensor Circuit High Voltage (Bank 2 Sensor 1)
P0153	O2 Sensor Circuit Slow Response (Bank 2 Sensor 1)
P0154	O2 Sensor Circuit No Activity Detected (Bank 2 Sensor 1)
P0155	O2 Sensor Heater Circuit Malfunction (Bank 2 Sensor 1)
P0171	Fuel Trim System Lean (Bank 1)
P0172	Fuel Trim too Rich (Bank 1)
P0174	Fuel Trim too Lean (Bank 2)
P0175	Fuel Trim too Rich (Bank 2)
P0230	Fuel Pump Primary Circuit Malfunction
P0300	Random/Multiple Cylinder Misfire Detected
P0325	Knock Sensor 1 Circuit Malfunction (Bank 1 or Single Sensor)
P0327	Knock Sensor 1 Circuit Low Input (Bank 1 or Single Sensor)

P0332	Knock Sensor 2 Circuit Low Input (Bank 2)
P0333	Knock Sensor 2 Circuit High Input (Bank 2)
P0335	Crankshaft Position Sensor A Circuit Malfunction
P0336	Crankshaft Position Sensor A Circuit Range/Performance
P0341	Camshaft Position Sensor Circuit Range/Performance
P0342	Camshaft Position Sensor Circuit Low Input
P0343	Camshaft Position Sensor Circuit High Input
P0351	Ignition Coil A Primary/Secondary Circuit Malfunction
P0352	Ignition Coil B Primary/Secondary Circuit Malfunction
P0353	Ignition Coil C Primary/Secondary Circuit Malfunction
P0354	Ignition Coil D Primary/Secondary Circuit Malfunction
P0355	Ignition Coil E Primary/Secondary Circuit Malfunction
P0356	Ignition Coil F Primary/Secondary Circuit Malfunction
P0357	Ignition Coil G Primary/Secondary Circuit Malfunction
P0358	Ignition Coil H Primary/Secondary Circuit Malfunction
P0480	Cooling Fan 1 Control Circuit Malfunction
P0500	Vehicle Speed Sensor Malfunction
P0506	Idle Control System RPM Lower Than Expected
P0507	Idle Control System RPM Higher Than Expected
P0530	A/C Refrigerant Pressure Sensor Circuit Malfunction
P0562	System Voltage Low
P0563	System Voltage High
P0601	Control Module Read Only Memory(ROM)
P0602	Control Module Programming Error
P0604	Internal Control Module Random Access Memory (RAM) Error
P0608	Control Module VSS Output "A" Malfunction
P0650	Malfunction Indicator Lamp (MIL) Control Circuit Malfunction
P0654	Engine RPM Output Circuit Malfunction
P1111	Intake Air Temperature (IAT) Sensor Circuit Intermittent High Voltage
P1112	Intake Air Temperature (IAT) Sensor Circuit Intermittent Low Voltage
P1114	Engine Coolant Temperature (ECT) Sensor Circuit Intermittent Low Voltage/IAT - B Circuit Low Input
P1115	Engine Coolant Temperature (ECT) Sensor Circuit Intermittent High Voltage/IAT - B Circuit High Input

P1121	Throttle Position (TP) Sensor Circuit Intermittent High Voltage
P1122	Throttle Position (TP) Sensor Circuit Intermittent Low Voltage
P1133	HO2S Insufficient Switching Sensor 1
P1134	HO2S Transition Time Ratio Sensor 1
P1153	Bank 2 Fuel Control Shifted Lean
P1154	Bank 2 Fuel Control Shifted Rich
P1258	Pedal Correlation PDS1 and PDS2
P1336	Crank / Cam Sensor Range / Performance
P1380	Misfire Detected - Rough Road Data Not Available
P1626	Theft Deterrent Fuel Enable Signal Not Received/ B+ Supply To VCRM A/C Circuit Malfunction
P1635	Tire / Axle Ratio Out of Acceptable Range
P1639	Vehicle ID Block Corrupted or Not Programmed

Torque Specifications

Application	Spec
Accelerator Control Cable Bracket Bolts	89 lb in
Air Conditioning Compressor Bolts	37 lb ft
Air Conditioning Compressor Bracket Bolts	37 lb ft
Air Conditioning Idler Pulley Bolt	37 lb ft
Air Conditioning Tensioner Bolt	18 lb ft
Air Injection Reaction (AIR) Pipe-to-Exhaust Manifold Bolts	15 lb ft
Camshaft Retainer Bolts	18 lb ft
Camshaft Sensor Bolt	18 lb ft
Camshaft Sprocket Bolts	26 lb ft
Catalytic Converter Nut	18 lb ft
Connecting Rod Bolts - First Design (First Pass)	15 lb ft
Connecting Rod Bolts - First Design (Final Pass)	60 degrees
Connecting Rod Bolts - Second Design (First Pass)	15 lb ft
Connecting Rod Bolts - Second Design (Final Pass)	75 degrees
Coolant Temperature Gauge Sensor	15 lb ft
Crankshaft Balancer Bolt (Installation Pass-to Ensure the Balancer is Completely Installed)	240 lb ft
Crankshaft Balancer Bolt (First Pass-Install a NEW Bolt After the Installation Pass and Tighten as Described in the First and Final Passes)	37 lb ft
Crankshaft Balancer Bolt (Final Pass)	140 degrees
Crankshaft Bearing Cap Bolts (Inner Bolts-First Pass in Sequence)	15 lb ft
Crankshaft Bearing Cap Bolts (Inner Bolts-Final Pass in Sequence)	80 degrees
Crankshaft Bearing Cap Side Bolts	18 lb ft
Crankshaft Bearing Cap Studs (Outer Studs-First Pass in Sequence)	15 lb ft
Crankshaft Bearing Cap Studs (Outer Studs-Final Pass in Sequence)	53 degrees
Crankshaft Oil Deflector Nuts	18 lb ft
Crankshaft Position Sensor Bolt	18 lb ft

Cylinder Head Bolts (First Pass all M11 Bolts in Sequence)	22 lb ft
Cylinder Head Bolts (Second Pass all M11 Bolts in Sequence)	90 degrees
Cylinder Head Bolts (Final Pass all M11 Bolts in Sequence-Excluding the Medium Length Bolts at the Front and Rear of Each Cylinder Head)	90 degrees
Cylinder Head Bolts (Final Pass M11 Medium Length Bolts at the Front and Rear of Each Cylinder Head in Sequence)	50 degrees
Cylinder Head Bolts (M8 Inner Bolts in Sequence)	22 lb ft
Cylinder Head Coolant Plug	15 lb ft
Cylinder Head Core Hole Plug	15 lb ft
Drive Belt Idler Pulley Bolt	37 lb ft
Drive Belt Tensioner Bolts	37 lb ft
Engine Block Coolant Drain Plugs	44 lb ft
Engine Block Heater	30 lb ft
Engine Block Oil Gallery Plugs	44 lb ft
Engine Coolant Air Bleed Pipe Bolts and Studs	106 lb in
Engine Crossmember Bolts (Large)	107 lb ft
Engine Crossmember Bolts (Small)	92 lb ft
Engine Flywheel Bolts (First Pass)	15 lb ft
Engine Flywheel Bolts (Second Pass)	37 lb ft
Engine Flywheel Bolts (Final Pass)	74 lb ft
Engine Flywheel-to-Torque Converter Bolts	44 lb ft
Engine Front Cover Bolts	18 lb ft
Engine Mount Heat Shield Nuts	89 lb in
Engine Mount Stud-to-Engine Block	37 lb ft
Engine Mount Through Bolts	70 lb ft
Engine Mount Through Bolt Nuts	59 lb ft
Engine Mount-to-Engine Block Bolts	37 lb ft
Engine Rear Cover Bolts	18 lb ft
Engine Service Lift Bracket M10 Bolts	37 lb ft
Engine Service Lift Bracket M8 Bolt	18 lb ft
Engine Valley Cover Bolts	18 lb ft
Engine Wire Harness Clip Bolt	37 lb ft
Engine Wire Harness Ground Strap Bolt	37 lb ft
Exhaust Gas Recirculation (EGR) Valve Bolts (First Pass)	89 lb in
EGR Valve Bolts (Final Pass)	22 lb ft
EGR Valve Pipe-to-Cylinder Head Bolts	37 lb ft
EGR Valve Pipe-to-Exhaust Manifold Bolts	22 lb ft
EGR Valve Pipe-to-Intake Manifold Bolt	89 lb in
Exhaust Manifold Bolts (First Pass)	11 lb ft
Exhaust Manifold Bolts (Final Pass)	18 lb ft
Exhaust Manifold Heat Shield Bolts	80 lb in
Exhaust Manifold Pipe Nuts	26 lb ft
Front Shock-to-Engine Crossmember Bolts	48 lb ft
Fuel Injection Fuel Rail Bolts	89 lb in
Generator Bracket Bolts	37 lb ft
Generator Rear Bracket-to-Engine Block Bolt	18 lb ft
Generator Rear Bracket-to-Generator Bolt	18 lb ft
Ground Strap Bolt (at Rear of Cylinder Head)	37 lb ft
Ignition Coil-to-Bracket Bolts	106 lb in

Ignition Coil Bracket-to-Valve Rocker Arm Cover Bolts	106 lb in
Intake Manifold Bolts (First Pass in Sequence)	44 lb in
Intake Manifold Bolts (Final Pass in Sequence)	89 lb in
Knock Sensors	15 lb ft
Oil Filter	22 lb ft
Oil Filter Fitting	40 lb ft
Oil Level Indicator Tube Bolt	18 lb ft
Oil Level Sensor	115 lb in
Oil Pan Baffle Bolts	106 lb in
Oil Pan Closeout Cover Bolt (Left Side)	106 lb in
Oil Pan Closeout Cover Bolt (Right Side)	106 lb in
Oil Pan Cover Bolts	106 lb in
Oil Pan Drain Plug	18 lb ft
Oil Pan M8 Bolts (Oil Pan-to-Engine Block and Oil Pan-to-Front Cover)	18 lb ft
Oil Pan M6 Bolts (Oil Pan-to-Rear Cover)	106 lb in
Oil Pressure Sensor	15 lb ft
Oil Pump-to-Engine Block Bolts	18 lb ft
Oil Pump Cover Bolts	106 lb in
Oil Pump Relief Valve Plug	106 lb in
Oil Pump Screen Nuts	18 lb ft
Oil Pump Screen-to-Oil Pump Bolt	106 lb in
Oxygen Sensor	31 lb ft
Positive Crankcase Ventilation (PCV) System Strap Nut (at Right Front Vapor Vent Pipe Stud)	106 lb in
Power Steering Pump Bolts	18 lb ft
Power Steering Pump Bracket Bolts	18 lb ft
Spark Plugs (Cylinder Heads-New)	15 lb ft
Spark Plugs (all Subsequent Installations)	11 lb ft
Throttle Body Bolts	106 lb in
Transmission Housing Bolt	37 lb ft
Valve Lifter Guide Bolts	106 lb in
Valve Rocker Arm Bolts	22 lb ft
Valve Rocker Arm Cover Bolts	106 lb in
Water Inlet Housing Bolts	11 lb ft
Water Pump Bolts (First Pass)	11 lb ft
Water Pump Bolts (Final Pass)	22 lb ft
Water Pump Cover Bolts	11 lb ft

LS1 PCM Pin-Outs



1997 Pin Connections
Red Connector

Pin #	Wire Color	Circuit Description
4	BROWN/WHITE	CAM POSITION SENSOR
7	YELLOW	VSS SIGNAL HIGH SIDE
9	PINK/BLACK	INJECTOR DRIVER #3
12	LIGHT BLUE/BLACK	INJECTOR DRIVER #4
13	PURPLE/WHITE	IGNITION DRIVER #2
14	DARK GREEN	A/C STATUS
15	BLACK/WHITE	INJECTOR DRIVER #5
18	YELLOW/BLACK	INJECTOR DRIVER #6
21	PURPLE	IAC SENSOR GROUND
22	DARK BLUE	TRANSMISSION RANGE SIGNAL B
23	LIGHT GREEN/BLACK	INJECTOR DRIVER #2
24	BLACK/WHITE	SENSOR GROUND JUMPER
25	PINK	TRANSMISSION RANGE SIGNAL A
26	BLACK/WHITE	PRND A
27	RED/BLACK	INJECTOR DRIVER #7
30	DARK BLUE/WHITE	REAL TIME DAMPING (W/F45)
31	DARK BLUE/WHITE	INJECTOR DRIVER #8
32	WHITE	PRND P
33	BLACK	INJECTOR DRIVER #1
34	GRAY or WHITE	2ND&3RD SOL(M/T) or SHIFT SOL 3-2 (A/T)
35	LIGHT GREEN	SHIFT SOLENOID A
37	BROWN	MIL DRIVER
39	DARK GREEN/WHITE	A/C CLUTCH RELAY DRIVER
40	WHT or YELLOW/BLK	1-4 UPSFT LIGHT (M/T) or SHIFT SOL B (A/T)
41	PINK/WHITE	PCM CHASSIS PITCH OUTPUT CIRCUIT
42	LIGHT GREEN	REVERSE INHABIT SOLENOID
43	DARK GREEN	COOLING FAN RELAY #1 DRIVER
44	DARK BLUE/WHITE	CRANKSHAFT POSITION SENSOR SIGNAL
45	DARK GREEN/WHITE	EVAP CANISTER PURGE VALVE CONTROL
46	ORANGE/BLACK	DESIRED TORQUE
47	DARK GREEN/WHITE	A/C REQUEST SIGNAL (C60)
48	YELLOW	MAF SENSOR SIGNAL
49	PURPLE	IGNITION DRIVER #1
52	RED/WHITE	IGNITION DRIVER #8
53	RED	IGNITION DRIVER #7
54	DARK GREEN/WHITE	IGNITION DRIVER #6
55	DARK GREEN/WHITE	VSS OUTPUT SIGNAL
56	DARK GREEN	IGNITION DRIVER #5
57	LIGHT BLUE/WHITE	IGNITION DRIVER #4
58	LIGHT BLUE	IGNITION DRIVER #3
59	BROWN/WHITE	IGNITION REFERENCE LOW BANK 2
60	BROWN	IGNITION REFERENCE LOW BANK 1
61	RED	TRANSMISSION RANGE SIGNAL C
63	BLACK	A/C REFRIGERANT PRESSURE GROUND
64	BLACK	ENGINE OIL PRESSURE SENSOR GROUND
65	GRAY	PRND C
66	YELLOW	PRND B
68	GRAY	CLUTCH SWITCH SIGNAL

69	BROWN	EVAP PURGE VACUUM SWITCH SIGNAL
71	PURPLE	VSS SIGNAL LOW
72	BLACK/WHITE	PCM GROUND
73	GRAY	EXTENDED TRAVEL BRAKE SWITCH
75	GRAY	LEFT&RIGHT FUEL TANK LEVEL GROUND
76	BLACK/WHITE	PCM GROUND
77	PURPLE	CRUISE/TCC BRAKE SWITCH SIGNAL
Blue Connector		
1	TAN	H02S SIGNAL LOW BANK 2 SENSOR 2
2	TAN/WHITE	H02S SIGNAL LOW BANK 1 SENSOR 2
4	RED	CAM POSITION SENSOR B+ SUPPLY
5	TAN	H02S SIGNAL LOW BANK 2 SENSOR 1
6	TAN/WHITE	H02S SIGNAL LOW BANK 1 SENSOR 1
7	RED/BLACK	A/C REFRIGERANT PRESSURE SIGNAL
8	TAN	IAT SENSOR SIGNAL
10	DARK BLUE	FUEL LEVEL SENSOR (LEFT) SIGNAL
11	GRAY	GENERATOR F TERMINAL
12	LIGHT BLUE	FUEL LEVEL SENSOR (RIGHT) SIGNAL
13	YELLOW/BLACK	TRANSMISSION FLUID TEMP SIGNAL
14	ORANGE/BLACK	TRANSMISSION FLUID TEMP GROUND
19	PINK	PCM IGNITION 1 FEED
20	ORANGE	PCM BATTERY FEED
21	BLACK/WHITE	PCM GROUND
22	YELLOW/BLACK	CRANKSHAFT POSITION SENSOR GROUND
24	BLACK/WHITE	SENSOR GROUND JUMPER
25	BROWN	ECT SENSOR GROUND
26	ORANGE/BLACK	MAP SENSOR GROUND
28	DARK BLUE	ENGINE COOLING FAN RELAY #2/3 DRIVER
30	BROWN	AIR PUMP RELAY DRIVER
31	PURPLE	AIR SOLENOID RELAY DRIVER
32	TAN/BLACK	TCC ENABLE SOLENOID
33	BROWN	TCC CONTROL (PWM) SOL CONTROL
35	WHITE	ENGINE SPEED (TACH) OUTPUT SIGNAL
36	LIGHT BLUE/WHITE	TRANS FLUID PSSURE CONTRL SOL LOW
37	DARK GREEN/WHITE	FUEL PUMP RELAY DRIVER
39	RED/BLACK	TRANS FLUID PSSURE CONTRL SOL HIGH
40	TAN/BLACK	TORQUE DELIVERED
41	PURPLE	H02S SIGNAL HIGH BANK 2 SENSOR 2
42	PURPLE/WHITE	H02S SIGNAL HIGH BANK 1 SENSOR 2
44	GRAY	FUEL LEVEL SENSORS 5v REFERENCE
45	GRAY	ENGINE OIL PRESSURE 5V REFERENCE
46	PURPLE	H02S SIGNAL HIGH BANK 2 SENSOR 1
47	PURPLE/WHITE	H02S SIGNAL HIGH BANK 1 SENOR 1
48	LIGHT GREEN	MAP SENSOR SIGNAL
49	YELLOW	ECT SENSOR SIGNAL
53	TAN/WHITE	ENGINE OIL PRESSURE SENSOR SIGNAL
58	DARK GREEN	SERIAL DATA CLASS 2
60	BLACK/WHITE	PCM GROUND
61	ORANGE	PCM BATTERY FEED
62	LIGHT GREEN	CRANK POSITON SENSOR B+ SUPPLY
64	GRAY	MAP SENSOR 5V REFERENCE

66	GRAY	A/C REFRIG PRESSURE SENSOR 5V REF
68	LIGHT BLUE	KNOCK SENSOR REAR
69	DARK BLUE	KNOCK SENSOR FRONT
70	PINK/BLACK	CAM POSITION SENSOR GROUND
71	TAN	TAC MODULE SERIAL DATA
72	ORANGE/BLACK	TAC MODULE SERIAL DATA
76	BROWN	OIL LEVEL SENSOR SIGNAL
77	RED	GENERATOR L TERMINAL

1998 Pin Connectors
Red Connector

3	WHITE	EVAP CANISTER VENT SOL VALVE
4	BROWN/WHITE	CAMSHAFT POSITION SENSOR
7	YELLOW	VSS SIGNAL RETURN
9	PINK/BLACK	INJECTOR DRIVER #3
11	DARK BLUE	VTD FUEL ENABLE
12	LIGHT BLUE/BLACK	INJECTOR DRIVER #4
13	RED/WHITE	IGNITION DRIVER #2
14	DARK GREEN	A/C STATUS
15	BLACK/WHITE	INJECTOR DRIVER #5
18	YELLOW/BLACK	INJECTOR DRIVER #6
21	PURPLE	IAT SENSOR GROUND
22	DARK BLUE	TRANSMISSION RANGE SIGNAL B
23	LIGHT GREEN/BLACK	INJECTOR DRIVER #2
24	BLACK/WHITE	SENSOR GROUND JUMPER
25	PINK	TRANSMISSION RANGE SIGNAL A
27	RED/BLACK	INJECTOR DRIVER #7
30	GRAY/BLACK	SPARK RETARD SIGNAL
31	DARK BLUE/WHITE	INJECTOR DRIVER #8
32	ORANGE/BLACK	PNP SWITCH SIGNAL
33	BLACK	INJECTOR DRIVER #1
34	GRAY or WHITE	SKIP SHIFT SOL (MT) or 3-2 SHIFT SOL (AT)
35	LIGHT GREEN	1-2 SHIFT SOLENOID
36	DARK BLUE	FUEL GAUGE OUTPUT
37	BROWN/WHITE	MIL DRIVER
39	DARK GREEN/WHITE	A/C CLUTCH RELAY CONTROL
40	WHT or YEL/BLACK	SKIP SHIFT LIGHT or 2-3 SHIFT SOL (AT)
41	BROWN/WHITE	LOW OIL LEVEL LIGHT CONTROL
42	LIGHT GREEN	REVERSE LOCK OUT SOL DRIVER
43	DARK GREEN	COOLING FAN RELAY #1 DRIVER
44	YELLOW	CRANK POSITION SENSOR INPUT
45	DARK GREEN/WHITE	EVAP CANISTER PURGE VALVE DRIVER
47	DARK GREEN/WHITE	A/C REQUEST SIGNAL
48	YELLOW	MAF SENSOR SIGNAL
49	PURPLE	IGNITION DRIVER #1
52	PURPLE/WHITE	IGNITION DRIVER #8
53	RED	IGNITION DRIVER #7
54	LIGHT BLUE/WHITE	IGNITION DRIVER #6
55	DARK GREEN/WHITE	VSS OUTPUT SIGNAL
56	DARK GREEN	IGNITION DRIVER #5
57	DARK GREEN/WHITE	IGNITION DRIVER #4
58	LIGHT BLUE	IGNITION DRIVER #3

59	BROWN/WHITE	IGNITION REFERENCE LOW BANK 2
60	BROWN	IGNITION REFERENCE LOW BANK 1
61	RED	TRANSMISSION RANGE SIGNAL C
62	BLACK	EGR PINTLE POSITION GROUND
63	BLACK	A/C REFRIG PRESSURE GROUND
71	PURPLE	VSS SIGNAL LOW
72	BLACK	PCM GROUND
75	GRAY	LEFT&RIGHT FUEL TK SENSOR GROUND
76	BLACK	PCM GROUND
77	PURPLE	TCC/BRAKE SWITCH SIGNAL

Blue Connector

1	TAN	H02S SIGNAL LOW BANK 2 SENSOR 2
2	TAN/WHITE	H02S SIGNAL LOW BANK 1 SENSOR 2
3	TAN	SERIAL DATA (UART)
4	RED	CAM POSITION SENSOR B+ SUPPLY
5	TAN	H02S SIGNAL LOW BANK 2 SENSOR 1
6	TAN/WHITE	H02S SIGNAL LOW BANK 1 SENSOR 1
7	RED/BLACK	A/C REFRIG PRESSURE SENSOR SIGNAL
8	TAN	IAT SENSOR SIGNAL
9	BROWN	EGR POSITION SENSOR SIGNAL
10	PURPLE	FUEL LEVEL SENSOR SIGNAL
12	DARK BLUE	TPS SIGNAL
13	YELLOW/BLACK	TRANSMISSION FLUID TEMP SIGNAL
14	ORANGE/BLACK	TRANSMISSION FLUID TEMP GROUND
19	PINK	PCM IGNITION 1 FEED
20	ORANGE	PCM BATTERY FEED
21	BLACK	PCM GROUND
22	YELLOW/BLACK	CRANK POSITION SENSOR GROUND
23	BLACK	TPS GROUND
24	BLACK/WHITE	SENSOR GROUND JUMPER
25	BROWN	ECT SENSOR GROUND
26	ORANGE/BLACK	MAP SENSOR GROUND
28	DARK BLUE	ENGINE COOLING FAN RELAY 2&3 DRIVER
30	BROWN	AIR PUMP RELAY DRIVER
31	PURPLE	AIR SOLENOID RELAY DRIVER
32	TAN/BLACK	TCC ENABLE RELAY DRIVER
33	BROWN	TCC (PWM) SOLENOID VALVE DRIVER
34	GRAY	EGR VALVE GROUND
35	WHITE	ENGINE SPEED (TACH) OUTPUT SIGNAL
36	LIGHT BLUE/WHITE	TRANS FLUID PSURE SOL CONTROL LOW
37	DARK GREEN/WHITE	FUEL PUMP RELAY DRIVER
38	LIGHT BLUE	EGR VALVE DRIVER CIRCUIT
39	RED/BLACK	TRANS FLUID PSURE SOL CONTROL HIGH
41	PURPLE	H02S SIGNAL HIGH BANK 2 SENSOR 2
42	PURPLE/WHITE	H02S SIGNAL HIGH BANK 1 SENSOR 2
43	GRAY	TPS 5V REFERENCE
46	PURPLE	H02S SIGNAL HIGH BANK 2 SENSOR 1
47	PURPLE/WHITE	H02S SIGNAL HIGH BANK 1 SENSOR 1
48	LIGHT GREEN	MAP SENSOR SIGNAL
49	YELLOW	ECT SENSOR SIGNAL
52	DARK GREEN	FUEL TANK PRESSURE SENSOR SIGNAL

54	LIGHT GREEN/BLACK	IAC COIL B LOW
55	LIGHT BLUE/BLACK	IAC COIL A LOW
56	LIGHT BLUE/WHITE	IAC COIL A LOW
57	LIGHT GREEN/WHITE	IAC COIL B HIGH
58	PURPLE	SERIAL DATA (CLASS 2)
60	BLACK	PCM GROUND
61	ORANGE	PCM BATTERY FEED
62	LIGHT GREEN	CRANK POSITION SENSOR B+ SUPPLY
64	GRAY	MAP SENSOR 5V REFERENCE
65	GRAY	5V REFERENCE
66	GRAY	A/C REFRIG PRESSURE 5V REFERENCE
67	GRAY	5V REFERENCE
68	LIGHT BLUE	KNOCK SENSOR REAR
69	DARK BLUE	KNOCK SENSOR FRONT
70	PINK/BLACK	CAMSHAFT POSITION SENSOR GROUND
76	BROWN	OIL LEVEL SENSOR SIGNAL

1999 PIN CONNECTIONS
Blue Connector

1	BLACK	PCM GROUND
2	LIGHT GREEN	CRANK POSITION SENSOR B+ SUPPLY
3	PINK/BLACK	INJECTION DRIVER #3
4	LIGHT GREEN/BLACK	INJECTION DRIVER #2
8	GRAY	TPS 5V REFERENCE
11	LIGHT BLUE	KNOCK SENSOR REAR
12	DARK BLUE/WHITE	CRANKSHAFT POSITION SIGNAL
17	DARK BLUE	TRANSMISSION RANGE B
18	RED	TRANSMISSION RANGE C
19	PINK	IGNITION FEED
20	ORANGE	BATTERY FEED
21	YELLOW/BLACK	CRANKSHAFT POSITION REFERENCE LOW
23	GRAY	FUEL TANK PRESSURE SENSOR/FUEL TANK SENDER GROUND
25	TAN	N02S SIGNAL LOW BANK 2 SENSOR 2
26	TAN	H02S SIGNAL LOW BANK 2 SENSOR 1
28	TAN/WHITE	H02S SIGNAL LOW BANK 1 SENSOR 2
29	TAN/WHITE	H02S SIGNAL LOW BANK 1 SENSOR 1
32	GRAY	CLUTCH PEDEL POSITION SWITCH SIGNAL
33	PURPLE	TCC BRAKE SWITCH
34	ORANGE/BLACK	PNP SWITCH SIGNAL
36	BLACK	INJECTOR DRIVER #1
37	YELLOW/BLACK	INJECTOR DRIVER #6
40	BLACK	PCM GROUND
41	BLACK	EGR PINTLE POSITION SENSOR GROUND
42	DARK GREEN	ENGINE COOLING FAN RELAY 1 DRIVER
43	RED/BLACK	INJECTOR DRIVER #7
44	LIGHT BLUE/BLACK	INJECTOR DRIVER #4
45	GRAY	A/C REFRIG PRESSURE SEN 5V REFERENCE
46	GRAY	FUEL TANK PRESSURE 5V REFERENCE
47	GRAY	EGR PINTLE POSITION 5V REFERENCE
48	GRAY	MAP SENSOR 5V REFERENCE
51	DARK BLUE	KNOCK SENSOR SIGNAL FRONT
53	BLACK	TRANS TEMP SENSOR GROUND

54	ORANGE/BLACK	MAP SENSOR GROUND
55	BROWN	EGR PINTLE POSITION SENSOR SIGNAL
57	ORANGE	BATTERY FEED
58	DARK GREEN	SERIAL DATA
60	BLACK	TPS GROUND
61	PINK/BLACK	CAM POSITION SENSOR REFERENCE LOW
65	PURPLE	H02S SIGNAL HIGH BANK 2 SENSOR 2
66	PURPLE	H02S SIGNAL HIGH BANK 2 SENSOR 1
88	PURPLE/WHITE	H02S SIGNAL HIGH BANK 1 SENSOR 2
89	PURPLE/WHITE	H02S SIGNAL HIGH BANK 1 SENSOR 1
70	BROWN	LOW OIL LEVEL SWITCH
73	BROWN/WHITE	CAM POSITION SENSOR SIGNAL
74	YELLOW	ENGINE COOLANT TEMP SIGNAL
76	BLACK/WHITE	INJECTION DRIVER #5
77	DARK BLUE/WHITE	INJECTION DRIVER #8
79	GRAY or WHITE	SKIP SHIFT SOL (M/T) or 2-3 SHIFT SOL (A/T)
80	BLACK	ENGINE COOLANT TEMP SENSOR GROUND
Red Connector		
1	BLACK	PCM GROUND
2	BROWN	TCC SOLENOID DRIVER
4	PURPLE	AIR SOLENOID DRIVER
6	RED/BLACK	TRANS PRESSURE SOL CONTROL HIGH
7	RED	EGR DRIVER
8	LIGHT BLUE/WHITE	TRANS PRESSURE SOL CONTROL LOW
9	DARK GREEN	FUEL PUMP RELAY DRIVER
10	WHITE	ENGINE SPEED (TACH) OUTPUT SIGNAL
13	WHITE	CRUISE CONTROL ENABLE SIGNAL
14	RED/BLACK	A/C REFRIG PRESSURE SENSOR SIGNAL
15	RED	ALTERNATOR TERMINAL
17	DARK GREEN/WHITE	A/C REQUEST SIGNAL
18	DARK GREEN	A/C STATUS SIGNAL
20	LIGHT GREEN/BLACK	VSS REFERENCE LOW
24	DARK BLUE	TPS SENSOR SIGNAL
25	TAN	IAT SENSOR SIGNAL
26	PURPLE	IGNITION DRIVER #1
27	RED	IGNITION DRIVER #7
28	LIGHT BLUE/WHITE	IGNITION DRIVER #6
29	DARK GREEN/WHITE	IGNITION DRIVER #4
30	DARK BLUE	VDT FUEL ENABLE SIGNAL
31	YELLOW	MAF SENSOR SIGNAL
32	LIGHT GREEN	MAP SENSOR SIGNAL
33	DARK BLUE	ENGINE COOLING FAN RELAY 2&3 DRIVER
34	DARK GREEN/WHITE	EVAP PURGE CANISTER VALVE DRIVER
36	BROWN	AIR PUMP RELAY DRIVER
37	DARK GREEN	CRUISE CONTROL INHIBIT
39	RED	CAM POSITION SENSOR B+ SUPPLY
40	BLACK	PCM GROUND
41	GRAY	EGR POSITION SENSOR GROUND
42	TAN/BLACK	TCC ENABLE CIRCUIT
43	DARK GREEN/WHITE	A/C CLUTCH RELAY CONTROL
44	LIGHT GREEN	REVERSE LOCK OUT SOL DRIVER

45	WHITE	EVAP CANISTER VENT VALVE DRIVER
46	BROWN/WHITE	MIL DRIVER
47	YELLOW/BLACK	TRANSMISSION SHIFT SOLENOID B
48	LIGHT GREEN	TRANSMISSION SHIFT SOLENOID A
50	DARK GREEN/WHITE	VEHICLE SPEED OUTPUT CIRCUIT
51	YELLOW/BLACK	TRANSMISSION TEMP SENSOR SIGNAL
53	GRAY/BLACK	SPARK RETARD SIGNAL
54	PURPLE	FUEL LEVEL SENSOR SIGNAL
57	PURPLE	IAC SENSOR GROUND
60	BROWN	IGNITION REFERENCE LOW BANK 1
61	BROWN/WHITE	IGNITION REFERENCE LOW BANK 1
63	PINK	TRANSMISSION RANGE SIGNAL A
64	DARK GREEN	FUEL TANK PRESSURE SENSOR SIGNAL
66	PURPLE/WHITE	IGNITION DRIVER #8
67	RED/WHITE	IGNITION DRIVER #2
68	DARK GREEN	IGNITION DRIVER #5
69	LIGHT BLUE	IGNITION DRIVER #3
76	LIGHT GREEN/WHITE	IAC COIL B HIGH
77	LIGHT GREEN/BLACK	IAC COIL B LOW
78	LIGHT BLUE	IAC COIL A LOW
79	LIGHT BLUE/WHITE	IAC COIL A HIGH

2000 PIN CONNECTIONS

	Blue Connector	
1	BLACK	PCM GROUND
2	LIGHT GREEN	CRANK POSITION SENSOR B+ SUPPLY
3	PINK/BLACK	INJECTOR DRIVER #3
4	LIGHT GREEN/BLACK	INJECTOR DRIVER #2
8	GRAY	TPS 5 VOLT REFERENCE
11	LIGHT BLUE	KNOCK SENSOR SIGNAL REAR
12	DARK BLUE/WHITE	CRANK POSITION SENSOR SIGNAL
17	DARK BLUE	TRANSMISSION RANGE SIGNAL B
18	RED	TRANSMISSION RANGE SIGNAL C
19	PINK	IGNITION POSITIVE VOLTAGE
20	ORANGE	BATTERY POSITIVE VOLTAGE
21	YELLOW/BLACK	CRANK POSITION SENSOR REF LOW
23	GRAY	F-TANK PRESS SENSOR/SENSOR GROUND
25	TAN	H02S SIGNAL LOW BANK 2 SENSOR 2
26	TAN	H02S SIGNAL LOW BANK 2 SENSOR 1
28	TAN/WHITE	H02S SIGNAL LOW BANK 1 SENSOR 2
29	TAN/WHITE	H02S SIGNAL LOW BANK 1 SENSOR 1
32	GRAY	CLUTCH PEDAL POSITION SWITCH SIGNAL
33	PURPLE	TCC BRAKE SWITCH
34	ORANGE/BLACK	PHP SWITCH SIGNAL
36	BLACK	INJECTOR DRIVER #1
37	YELLOW/BLACK	INJECTOR DRIVER #8
40	BLACK	PCM GROUND
41	BLACK	EGR PINTLE POSITION SENSOR GROUND
42	DARK GREEN	ENGINE COOLING FAN RELAY 1 DRIVER
43	RED/BLACK	INJECTOR DRIVER #7
44	LIGHT BLUE/BLACK	INJECTOR DRIVER #4
45	GRAY	A/C REFRIG PRESSURE SENSOR 5V REF

46	GRAY	FUEL TANK PRESSURE SENSOR 5V REF
47	GRAY	EGR PINTLE POSITION SENSOR 5V REF
48	GRAY	MAP SENSOR 5V REFERENCE
51	DARK BLUE	KNOCK SENSOR SIGNAL FRONT
53	BLACK	TRANSMISSION TEMP SENSOR GROUND
54	ORANGE/BLACK	MAP SENSOR GROUND
55	BROWN	EGR PINTLE POSITION SENSOR SIGNAL
57	ORANGE	BATTERY FEED
58	DARK GREEN	SERIAL DATA
80	BLACK	TPS GROUND
61	PINK/BLACK	CAM POSITION SENSOR REF LOW
85	PURPLE	H02S SIGNAL HIGH BANK 2 SENSOR 2
66	PURPLE	H02S SIGNAL HIGH BANK 2 SENSOR 1
68	PURPLE/WHITE	H02S SIGNAL HIGH BANK 1 SENSOR 2
69	PURPLE/WHITE	H02S SIGNAL HIGH BANK 1 SENSOR 1
70	BROWN	LOW OIL LEVEL SWITCH
73	BROWN/WHITE	CAM POSITION SENSOR SIGNAL
74	YELLOW	ENGINE COOLANT TEMP SENSOR SIGNAL
76	BLACK/WHITE	INJECTOR DRIVER #5
77	DARK BLUE/WHITE	INJECTOR DRIVER #8
79	GRAY or WHITE	SKIP SHIFT SOL (M/T) or 3-2 SHIFT SOL (A/T)
80	BLACK	ENGINE COOLANT TEMP SENSOR GROUND
Red Connector		
1	BLACK	PCM GROUND
2	BROWN	TCC DRIVER SOLENOID
4	PURPLE	AIR SOLENOID RELAY CONTROL
6	RED/BLACK	TRANS FLUID PRESSURE SOL HIGH
7	RED	EGR CONTROL
8	LIGHT BLUE/WHITE	TRANS FLUID PRESSURE SOL LOW
9	DARK GREEN/WHITE	FUEL PUMP RELAY DRIVER
10	WHITE	ENGINE SPEED (TACH) OUTPUT SIGNAL
13	WHITE	CRUISE CONTROL ENABLE SIGNAL
14	RED/BLACK	A/C REFRIGERANT PRESSURE SIGNAL
15	RED	ALTERNATOR L TERMINAL
17	DARK GREEN/WHITE	A/C REQUEST SIGNAL
18	DARK GREEN	A/C STATUS SIGNAL
20	LIGHT GREEN/BLACK	VEHICLE SPEED SENSOR (VSS) REF LOW
21	PURPLE/WHITE	VEHICLE SPEED SENSOR (VSS) SIGNAL
24	DARK BLUE	TPS SIGNAL
25	TAN	IAT SIGNAL
26	PURPLE	IGNITION COIL DRIVER #1
27	RED	IGNITION COIL DRIVER #7
28	LIGHT BLUE/WHITE	IGNITION COIL DRIVER #8
29	DARK GREEN/WHITE	IGNITION COIL DRIVER #4
30	DARK BLUE	VTD FUEL ENABLE SIGNAL
31	YELLOW	MAF SENSOR SIGNAL
32	LIGHT GREEN	MAP SENSOR SIGNAL
33	DARK GREEN	ENGINE COOLING FAN RELAY 2&3 DRIVER
34	DARK GREEN/WHITE	EVAP CANISTER PURGE VALVE DRIVER
36	BROWN	AIR PUMP RELAY DRIVER
37	DARK GREEN	CRUISE CONTROL INHIBIT

39	RED	CAM POSITION SENSOR B+ SUPPLY
40	BLACK	PCM GROUND
41	GRAY	EGR POSITION SENSOR GROUND
42	TAN/BLACK	TCC ENABLE CIRCUIT
43	DARK GREEN/WHITE	A/C CLUTCH RELAY DRIVER
44	LIGHT GREEN	REVERSE LOCK OUT SOL DRIVER
45	WHITE	EVAP CANISTER VENT VALVE DRIVER
46	BROWN/WHITE	MIL DRIVER
47	YELLOW/BLACK	TRANSMISSION SHIFT SOL B
48	LIGHT GREEN	TRANSMISSION SHIFT SOL A
50	DARK GREEN/WHITE	VEHICLE SPEED OUTPUT CIRCUIT
51	YELLOW/BLACK	TRANSMISSION TEMP SENSOR SIGNAL
53	GRAY/BLACK	SPARK RETARD SIGNAL
54	PURPLE	FUEL LEVEL SENSOR SIGNAL
57	PURPLE	IAT SENSOR GROUND
60	BROWN	IGNITION REF LOW BANK 1
61	BROWN/WHITE	IGNITION REF LOW BANK 2
63	PINK	TRANSMISSION RANGE SIGNAL A
64	DARK GREEN	FUEL TANK PRESSURE SENSOR SIGNAL
66	PURPLE/WHITE	IGNITION COIL DRIVER #8
67	RED/WHITE	IGNITION COIL DRIVER #2
68	DARK GREEN	IGNITION COIL DRIVER #5
69	LIGHT BLUE	IGNITION COIL DRIVER #3
76	LIGHT GREEN/WHITE	IAC COIL B HIGH
77	LIGHT GREEN/BLACK	IAC COIL B LOW
78	LIGHT BLUE/BLACK	IAC COIL A LOW
79	LIGHT BLUE/WHITE	IAC COIL A HIGH
<u>2000 Corvette only</u> <u>Blue Connector</u>		
1	BLACK/WHITE	PCM GROUND
2	LIGHT GREEN	CRANK POSITION SENSOR B+ SUPPLY
3	PINK/BLACK	INJECTOR DRIVER #3
4	LIGHT GREEN/BLACK	INJECTOR DRIVER #2
7	GRAY	ENGINE OIL PRESSURE 5V REFERENCE
11	LIGHT BLUE	KNOCK SENSOR SIGNAL REAR
12	DARK BLUE/WHITE	CRANK POSITION SENSOR SIGNAL
13	ORANGE/BLACK	REQUESTED TORQUE SIGNAL
14	TAN	THROTTLE ACTUATOR SERIAL DATA
15	ORANGE/BLACK	THROTTLE ACTUATOR SERIAL DATA
17	DARK BLUE	TRANS RANGE SIGNAL B
18	RED	TRANS RANGE SIGNAL C
19	PINK	PCM IGNITION SUPPLY
20	ORANGE	PCM BATTERY SUPPLY
21	YELLOW/BLACK	CRANK POSITION SENSOR GROUND
23	GRAY	F-TANK PRESS SENSOR/ SENSOR GROUND
25	TAN	H02S SIGNAL LOW BANK 2 SENSOR 2
26	TAN	H02S SIGNAL LOW BANK 2 SENSOR 1
28	TAN/WHITE	H02S SIGNAL LOW BANK 1 SENSOR 2
29	TAN/WHITE	H02S SIGNAL LOW BANK 1 SENSOR 1
32	BLACK/WHITE	PRND A INPUT SIGNAL (A/T ONLY)
33	PURPLE	TCC BRAKE SWITCH (A/T ONLY)

34	WHITE	PRND INPUT SIGNAL (A/T ONLY)
35	GRAY	CLUTCH SWITCH (MT ONLY)
36	BLACK	INJECTOR DRIVER #1
37	YELLOW/BLACK	INJECTOR DRIVER #6
38	PINK/WHITE	CHASSIS PITCH SIGNAL (IF EQUIPPED)
40	BLACK/WHITE	PCM GROUND
42	DARK GREEN	ENGINE COOLING FAN RELAY #1 DRIVER
43	RED/BLACK	INJECTOR DRIVER #7
44	LIGHT BLUE/BLACK	INJECTOR DRIVER #4
45	GRAY	A/C REFRIG PRESSURE SENSOR 5V REF
46	GRAY	FUEL TANK PRESSURE SENSOR 5V REF
48	GRAY	MAP SENSOR 5V REFERENCE
51	DARK BLUE	KNOCK SENSOR SIGNAL FRONT
53	ORANGE/BLACK	TRANS TEMP SENSOR GROUND
54	ORANGE BLACK	MAP SENSOR GROUND
57	ORANGE	PCM BATTERY SUPPLY
58	DARK GREEN	SERIAL DATA
60	BLACK	A/C REFRIG PRESSURE SENSOR GROUND
61	PINK/BLACK	CAM POSITION SENSOR GROUND
62	GRAY	EXTEND TRAVEL BRAKE SWITCH SIGNAL
63	BLACK	ENGINE OIL PRESSURE SENSOR GROUND
65	PURPLE	H02S SIGNAL HIGH BANK 2 SENSOR 2
66	PURPLE	H02S SIGNAL HIGH BANK 2 SENSOR 1
68	PURPLE/WHITE	H02S SIGNAL HIGH BANK 1 SENSOR 2
69	PURPLE/WHITE	H02S SIGNAL HIGH BANK 1 SENSOR 1
70	BROWN	LOW OIL LEVEL SWITCH
72	YELLOW	PRND B INPUT SIGNAL (A/T ONLY)
73	BROWN/WHITE	CAM POSITION SENSOR SIGNAL
74	YELLOW	ENGINE COOLANT TEMP SENSOR SIGNAL
76	BLACK/WHITE	INJECTOR DRIVER #5
77	DARK BLUE/WHITE	INJECTOR DRIVER #8
79	GRAY or WHITE	SKIP SHIFT SOL or 3-2 SHIFT SOL DRIVER
80	BROWN	ENGINE COOLANT TEMP SENSOR GROUND

Red Connector

1	BLACK/WHITE	PCM GROUND (A/T ONLY)
2	BROWN	TCC SOL (A/T ONLY)
4	PURPLE	AIR SOL DRIVER
5	TAN/BLACK	TORQUE DELIVERED
6	RED/BLACK	TRANS FLUID PRESS SOL HIGH (A/T ONLY)
8	LIGHT BLUE/WHITE	TRANS FLUID PRESS SOL LOW (A/T ONLY)
9	DARK GREEN/WHITE	FUEL PUMP RELAY DRIVER
10	WHITE	ENGINE SPEED (TACH) OUTPUT SIGNAL
14	RED/BLACK	A/C REFRIG PRESSURE SENSOR SIGNAL
15	RED	ALTERNATOR L TERMINAL
17	DARK GREEN/WHITE	A/C REQUEST SIGNAL
18	DARK GREEN	A/C STATUS SIGNAL
20	PURPLE	VEHICLE SPEED SENSOR (VSS) REF LOW
21	YELLOW	VEHICLE SPEED SENSOR (VSS) SIGNAL
25	TAN	IAT SENSOR SIGNAL
26	PURPLE	IGNITION COIL DRIVER #1
27	RED	IGNITION COIL DRIVER #7

28	LIGHT BLUE/WHITE	IGNITION COIL DRIVER #6
29	DARK GREEN/WHITE	IGNITION COIL DRIVER #4
31	YELLOW	MAF SENSOR SIGNAL
32	LIGHT GREEN	MAP SENSOR SIGNAL
33	DARK BLUE	COOLING FAN RELAY 2&3 DRIVER
34	DARK GREEN/WHITE	EVAP CANISTER PURGE VALVE DRIVER
36	BROWN	AIR PUMP RELAY CONTROL
39	RED	CAM POSITION SENSOR B+ SUPPLY
40	BLACK/WHITE	PCM GROUND
42	TAN/BLACK	TCC ENABLE CIRCUIT (A/T ONLY)
43	DARK GREEN/WHITE	A/C CLUTCH RELAY DRIVER
44	LIGHT GREEN	REVERSE LOCK OUT SOL DRIVER
45	WHITE	EVAP CANISTER VENT VALVE DRIVER
46	BROWN/WHITE	MIL INDICATOR LAMP DRIVER
47	WHITE or YELLOW/BLACK	1 to 4 UP SHIFT LIGHT or TRANS SHIFT SOL B
48	LIGHT GREEN	TRANS SHIFT SOL A
50	DARK GREEN/WHITE	VEHICLE SPEED OUTPUT CIRCUIT
51	YELLOW/BLACK	TRANS TEMP SENSOR SIGNAL
52	GRAY	ALTERNATOR F TERMINAL
54	DARK BLUE	FUEL LEVEL SENSOR SIGNAL
57	PURPLE	IAT GROUND
58	TAN/WHITE	ENGINE OIL PRESSURE SENSOR SIGNAL
60	BROWN	IGNITION CONTROL REF LOW BANK 1
61	BROWN/WHITE	IGNITION CONTROL REF LOW BANK 2
62	GRAY	PRND C INPUT SIGNAL (A/T ONLY)
63	PINK	TRANS RANGE SIGNAL A (A/T ONLY)
64	DARK GREEN	FUEL TANK PRESSURE SENSOR SIGNAL
66	PURPLE/WHITE	IGNITION COIL DRIVER #8
67	RED/WHITE	IGNITION COIL DRIVER #2
68	DARK GREEN	IGNITION COIL DRIVER #5
69	LIGHT BLUE	IGNITION COIL DRIVER #3
73	LIGHT BLUE	FUEL LEVEL SEN SIGNAL (SECONDARY)

2001 Pin Connections
Blue Connector

1	BLACK/WHITE	PCM GROUND
2	LIGHT GREEN	12 VOLT REFERENCE
3	PINK/BLACK	INJECTOR DRIVER #3
4	LIGHT GREEN/BLACK	INJECTOR DRIVER #2
8	GRAY	5 VOLT REFERENCE
11	LIGHT BLUE	KNOCK SENSOR REAR
12	DARK BLUE/WHITE	CRANK POSITION SENSOR SIGNAL
17	DARK BLUE	TRANS FLUID PRESS SWITCH SIGNAL B
18	ORANGE	TRANS FLUID PRESS SWITCH SIGNAL C
19	PINK	IGNITION FEED 12V
20	RED/WHITE	BATTERY FEED
21	YELLOW/BLACK	CRANK POSITION SENSOR LOW REF
23	GRAY	F-TANK PRESS SENSOR/SENDER GROUND
25	TAN	H02S LOW SIGNAL BANK 2 SENSOR 2
26	TAN	H02S LOW SIGNAL BANK 2 SENSOR 1
28	TAN/WHITE	H02S LOW SIGNAL BANK 1 SENSOR 2
29	TAN/WHITE	H02S LOW SIGNAL BANK 1 SENSOR 1

32	GRAY	CLUTCH PEDAL SWITCH SIGNAL
33	PURPLE	TCC BRAKE SWITCH SIGNAL
34	ORANGE/BLACK	NEUTRAL SAFETY SWITCH SIGNAL
36	TAN	INJECTOR DRIVER #1
37	YELLOW/BLACK	INJECTOR DRIVER #6
40	BLACK/WHITE	GROUND
42	DARK GREEN	COOLING FAN RELAY #1 DRIVER
43	ORANGE/BLACK	INJECTOR DRIVER #7
44	LIGHT BLUE/BLACK	INJECTOR DRIVER #4
45	GRAY	5V REF A/C REFRIG PRESSURE SENSOR
46	GRAY	5V REF FUEL TANK PRESSURE SENSOR
48	GRAY	5V REFERENCE MAP SENSOR
51	DARK BLUE	KNOCK SENSOR FRONT
53	TAN	LOW REF TRANSMISSION TEMP SENSOR
54	TAN	LOW REF MAP SENSOR GROUND
57	RED/WHITE	BATTERY FEED
58	DARK GREEN	ECM/PCM/ECM CLASS 2 SERIAL DATA
60	TAN	LOW REFERENCE TPS
61	PINK/BLACK	LOW REFERENCE CAM POSITION SENSOR
65	PURPLE	H02S HIGH SIGNAL BANK 2 SENSOR 2
66	PURPLE	H02S HIGH SIGNAL BANK 2 SENSOR 1
68	PURPLE/WHITE	H02S HIGH SIGNAL BANK 1 SENSOR 2
69	PURPLE/WHITE	H02S HIGH SIGNAL BANK 1 SENSOR 1
70	BROWN	OIL LEVEL SWITCH SIGNAL
73	BROWN/WHITE	CAM SENSOR SIGNAL
74	YELLOW	ECT SENSOR SIGNAL
76	TAN/WHITE	INJECTOR DRIVER #5
77	DARK BLUE/WHITE	INJECTOR DRIVER #8
79	GRAY or WHITE	SKIP SHIFT SOL (MT) or 3-2 SHIFT SOL (AT)
80	TAN	LOW REFERENCE ECT
Red Connector		
1	BLACK/WHITE	PCM GROUND
2	BROWN	TCC SOL OUTPUT (PWM)
4	PURPLE	AIR SOL RELAY DRIVER
6	ORANGE/BLACK	PC SOL VALVE HIGH DRIVER (SOL A)
8	LIGHT BLUE/WHITE	PC SOL VALVE LOW DRIVER (SOL A)
9	DARK GREEN/WHITE	FUEL PRESSUR RELAY DRIVER (PRIMARY)
10	WHITE	ENGINE SPEED (TACH) SIGNAL
13	WHITE	CRUISE CONTROL ENGAGE SIGNAL
14	ORANGE/BLACK	A/C REFRIG PRESSURE SENSOR SIGNAL
15	ORANGE	GENERATOR TURN ON SIGNAL
17	DARK GREEN/WHITE	A/C REQUEST SIGNAL
18	DARK GREEN	A/C COMPRESS CLUTCH SUPPLY VOLTAGE
20	LIGHT GREEN/BLACK	VSS LOW SIGNAL
21	PURPLE/WHITE	VSS HIGH SIGNAL
24	DARK BLUE	TPS SIGNAL
25	TAN	IAT SENSOR SIGNAL
26	PURPLE	IGNITION COIL DRIVER #1
27	ORANGE	IGNITION COIL DRIVER #7
28	LIGHT BLUE/WHITE	IGNITION COIL DRIVER #6
29	DARK GREEN/WHITE	IGNITION COIL DRIVER #4

30	DARK BLUE	FUEL ENABLE SIGNAL
31	YELLOW	MAF SENSOR SIGNAL
32	LIGHT GREEN	MAP SENSOR SIGNAL
33	DARK BLUE	COOLING FAN RELAY 2&3 DRIVER
34	DARK GREEN/WHITE	EVAP CANISTER PURGE SOL DRIVER
36	BROWN	AIR PUMP RELAY DRIVER
37	DARK GREEN	CRUISE CONTROL INHIBIT SIGNAL
39	ORANGE	12 VOLT REFERENCE
40	BLACK/WHITE	GROUND
42	TAN/BLACK	TCC SOL VALVE DRIVER
43	DARK GREEN/WHITE	A/C CLUTCH RELAY DRIVER
44	LIGHT GREEN	REVERSE LOCK OUT SOL DRIVER
45	WHITE	EVAP CANISTER VENT SOL DRIVER
46	BROWN/WHITE	MIL DRIVER
47	YELLOW/BLACK	2-3 SHIFT SOL VALVE DRIVER
48	LIGHT GREEN	1-2 SHIFT SOL VALVE DRIVER
50	DARK GREEN/WHITE	VSS SIGNAL
51	YELLOW/BLACK	TFT SENSOR SIGNAL
53	GRAY/BLACK	IGNITION RETARD SIGNAL
54	PURPLE	FUEL LEVEL SENSOR SIGNAL
57	PURPLE	LOW REFERENCE IAT
60	BROWN	IGNITION LOW REF BANK 1
61	BROWN/WHITE	IGNITION LOW REF BANK 2
63	PINK	TRANS FLUID PRESSUR SWITCH SIGNAL A
64	DARK GREEN	FUEL TANK PRESSURE SENSOR SIGNAL
66	PURPLE/WHITE	IGNITION COIL DRIVER #8
67	ORANGE/WHITE	IGNITION COIL DRIVER #2
68	DARK GREEN	IGNITION COIL DRIVER #5
69	LIGHT GREEN	IGNITION COIL DRIVER #3
76	LIGHT GREEN/WHITE	IAC COIL B HIGH
77	LIGHT GREEN/BLACK	IAC COIL B LOW
78	LIGHT BLUE/BLACK	IAC COIL A LOW
79	LIGHT BLUE/WHITE	IAC COIL A HIGH

2002 Pin Connectors
Blue Connector

1	BLACK	PCM GROUND
2	LIGHT GREEN	CRANK POSITION SENSOR B+ SUPPLY
3	PINK/BLACK	INJECTOR DRIVER #3
4	LIGHT GREEN/BLACK	INJECTOR DRIVER #2
8	GRAY	TPS 5V REFERENCE
11	LIGHT BLUE	KNOCK SENSOR REAR
12	DARK BLUE/WHITE	CRANK POSITION SENSOR SIGNAL
17	DARK BLUE	TRANS FLUID PRESSUR SWITCH SIGNAL B
18	RED	TRANS FLUID PRESSUR SWITCH SIGNAL C
19	PINK	IGNITION FEED
20	ORANGE	BATTERY FEED
21	YELLOW/BLACK	CRANK POSITION SENSOR LOW REF
23	GRAY	F-TANK PRESS SENSOR/SENDER LOW REF
25	TAN	H02S LOW SIGNAL BANK 2 SENSOR 2
26	TAN	H02S LOW SIGNAL BANK 2 SENSOR 1
28	TAN/WHITE	H02S LOW SIGNAL BANK 1 SENSOR 2

29	TAN/WHITE	H02S LOW SIGNAL BANK 1 SENSOR 1
32	GRAY	CLUTCH PEDEL POSITION SWITCH
33	PURPLE	TCC BRAKE SWITCH
34	ORANGE/BLACK	NEUTRAL SAFETY SWITCH SIGNAL
36	BLACK	INJECTOR DRIVER #1
37	YELLOW/BLACK	INJECTOR DRIVER #6
40	BLACK	GROUND
42	DARK GREEN	COOLING FAN RELAY 1 DRIVER
43	RED/BLACK	INJECTOR DRIVER #7
44	LIGHT BLUE/BLACK	INJECTOR DRIVER #4
45	GRAY	5V REF A/C REFRIG PRESSURE SENSOR
46	GRAY	5V REF FUEL TANK PRESSURE SENSOR
48	GRAY	5V REFERENCE MAP SENSOR
51	DARK BLUE	KNOCK SENSOR FRONT
53	BLACK	LOW REF TRANS TEMP SENSOR
54	BLACK	LOW REFERENCE MAP SENSOR
57	ORANGE	BATTERY FEED
58	DARK GREEN	ECM/PCM/VCM CLASS 2 SERIAL DATA
60	BLACK	LOW REFERENCE TPS
61	PINK/BLACK	LOW REFERENCE CAM POSITION SENSOR
65	PURPLE	H02S HIGH SIGNAL BANK 2 SENSOR 2
66	PURPLE	H02S HIGH SIGNAL BANK 2 SENSOR 1
68	PURPLE/WHITE	H02S HIGH SIGNAL BANK 1 SENSOR 2
69	PURPLE/WHITE	H02S HIGH SIGNAL BANK 1 SENSOR 1
70	BROWN	OIL LEVEL SWITCH SIGNAL
73	BROWN/WHITE	CAM POSITION SENSOR SIGNAL
74	YELLOW	ECT SENSOR SIGNAL
78	BLACK/WHITE	INJECTOR DRIVER #5
77	DARK BLUE/WHITE	INJECTOR DRIVER #8
79	GRAY or WHITE	SKIP SHIFT SOL (M/T) or 3-2 SHIFT SOL (A/T)
80	BLACK	LOW REFERENCE ECT SENSOR
Red Connector		
1	BLACK	PCM GROUND
2	BROWN	TCC SOL OUTPUT
4	PINK/BLACK	AIR RELAY COIL DRIVER
6	RED/BLACK	PC SOL VALVE HIGH DRIVER SOL A
8	LIGHT BLUE/WHITE	PC SOL VALVE LOW DRIVER SOL A
9	DARK GREEN/WHITE	FUEL PUMP RELAY DRIVER PRIMARY
10	WHITE	ENGINE SPEED SIGNAL (TACH)
13	WHITE	CRUISE CONTROL ENGAGE SIGNAL
14	RED/BLACK	AC REFRIG PRESSURE SENSOR SIGNAL
15	RED	ALTERNATOR TURN ON SIGNAL
17	DARK GREEN/WHITE	AC REQUEST SIGNAL
18	DARK GREEN	AC COMPRESSOR CLUTCH B+ SUPPLY
20	LIGHT GREEN/BLACK	VSS LOW SIGNAL
21	PURPLE/WHITE	VSS HIGH SIGNAL
24	DARK BLUE	TPS SIGNAL
25	TAN	IAT SENSOR SIGNAL
26	PURPLE	IGNITION COIL DRIVER #1
27	RED	IGNITION COIL DRIVER #7
28	LIGHT BLUE/WHITE	IGNITION COIL DRIVER #6

29	DARK GREEN/WHITE	IGNITION COIL DRIVER #4
30	DARK BLUE	FUEL ENABLE (KEYPASS II)
31	YELLOW	MAF SENSOR SIGNAL
32	LIGHT GREEN	MAP SENSOR SIGNAL
33	DARK BLUE	COOLING FAN RELAY 2&3 DRIVER
34	DARK GREEN/WHITE	EVAP CANISTER PURGE SOL DRIVER
36	BROWN	AIR PUMP RELAY DRIVER
37	DARK GREEN	CRUISE CONTROL INHIBIT SIGNAL
39	RED	CAM POSITION SENSOR B+ SUPPLY
40	BLACK	PCM GROUND
42	TAN/BLACK	TCC SOL VALVE DRIVER
43	DARK GREEN/WHITE	AC CLUTCH RELAY DRIVER
44	LIGHT GREEN	REVERSE LOCK OUT SOL DRIVER
45	WHITE	EVAP CANISTER VEN SOL DRIVER
46	BROWN/WHITE	MIL DRIVER
47	YELLOW/BLACK	2-3 SHIFT SOL VALVE DRIVER
48	LIGHT GREEN	1-2 SHIFT SOL VALVE DRIVER
50	DARK GREEN/WHITE	VSS SIGNAL
51	YELLOW/BLACK	TFT SENSOR SIGNAL
53	GRAY/BLACK	IGNITION RETARD SIGNAL
54	PURPLE	FUEL LEVEL SENSOR SIGNAL
57	PURPLE	FUEL LEVEL SENSOR SIGNAL
60	BROWN	IGNITION LOW REF BANK 1
61	BROWN/WHITE	IGNITION LOW REF BANK 2
63	PINK	TRANS FLUID PRESSUR SWITCH SIGNAL A
64	DARK GREEN	FUEL TANK PRESSURE SIGNAL
66	PURPLE/WHITE	IGNITION COIL DRIVER #8
67	RED/WHITE	IGNITION COIL DRIVER #2
68	DARK GREEN	IGNITION COIL DRIVER #5
69	LIGHT BLUE	IGNITION COIL DRIVER #3
76	LIGHT GREEN/WHITE	IAC COIL B HIGH
77	LIGHT GREEN/BLACK	IAC COIL B LOW
78	LIGHT BLUE/BLACK	IAC COIL A LOW
79	LIGHT BLUE/WHITE	IAC COIL A HIGH

The following sample diagrams are the required diagrams to make your own stand alone wiring harness using a 2001 Camaro SS PCM and stock harness also from a 2001 Camaro SS harness. If you are not using a 2001 harness, you will just be changing the pcm pin numbers and wire colors.

CHARGING SYSTEM

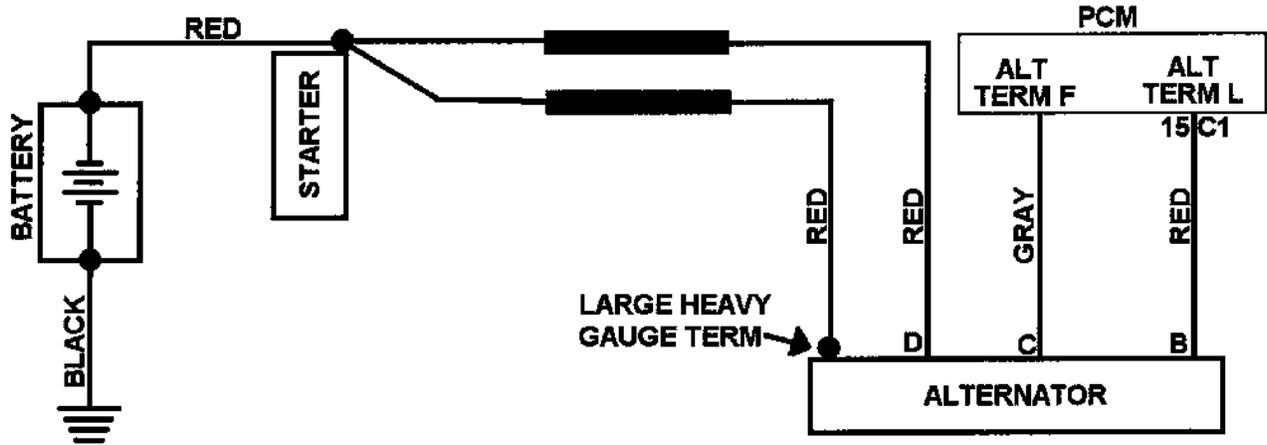

IAC VALVE WIRING

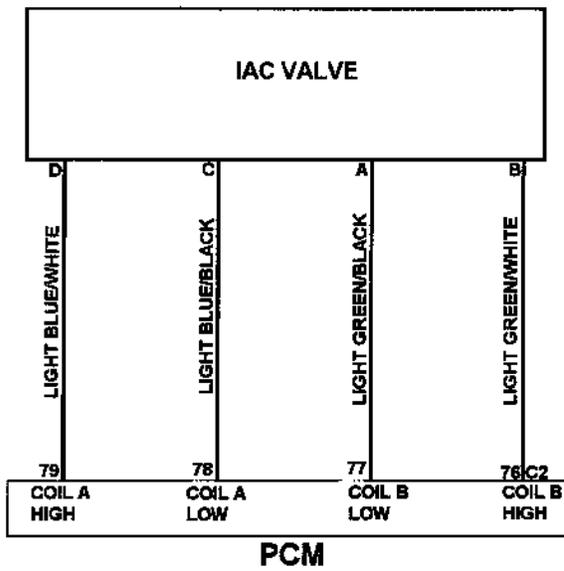

VEHICLE SPEED SENSOR

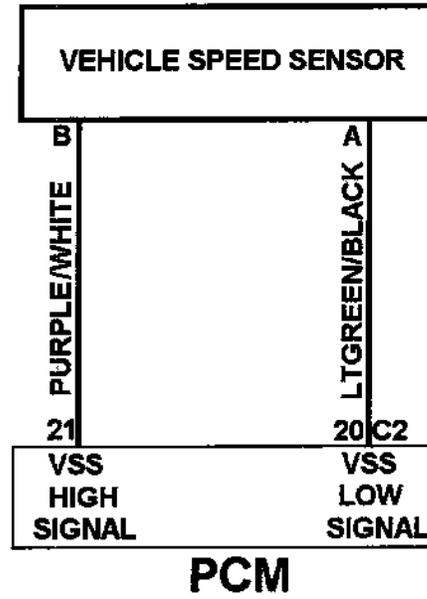

PCM POWER FEEDS & GROUNDS

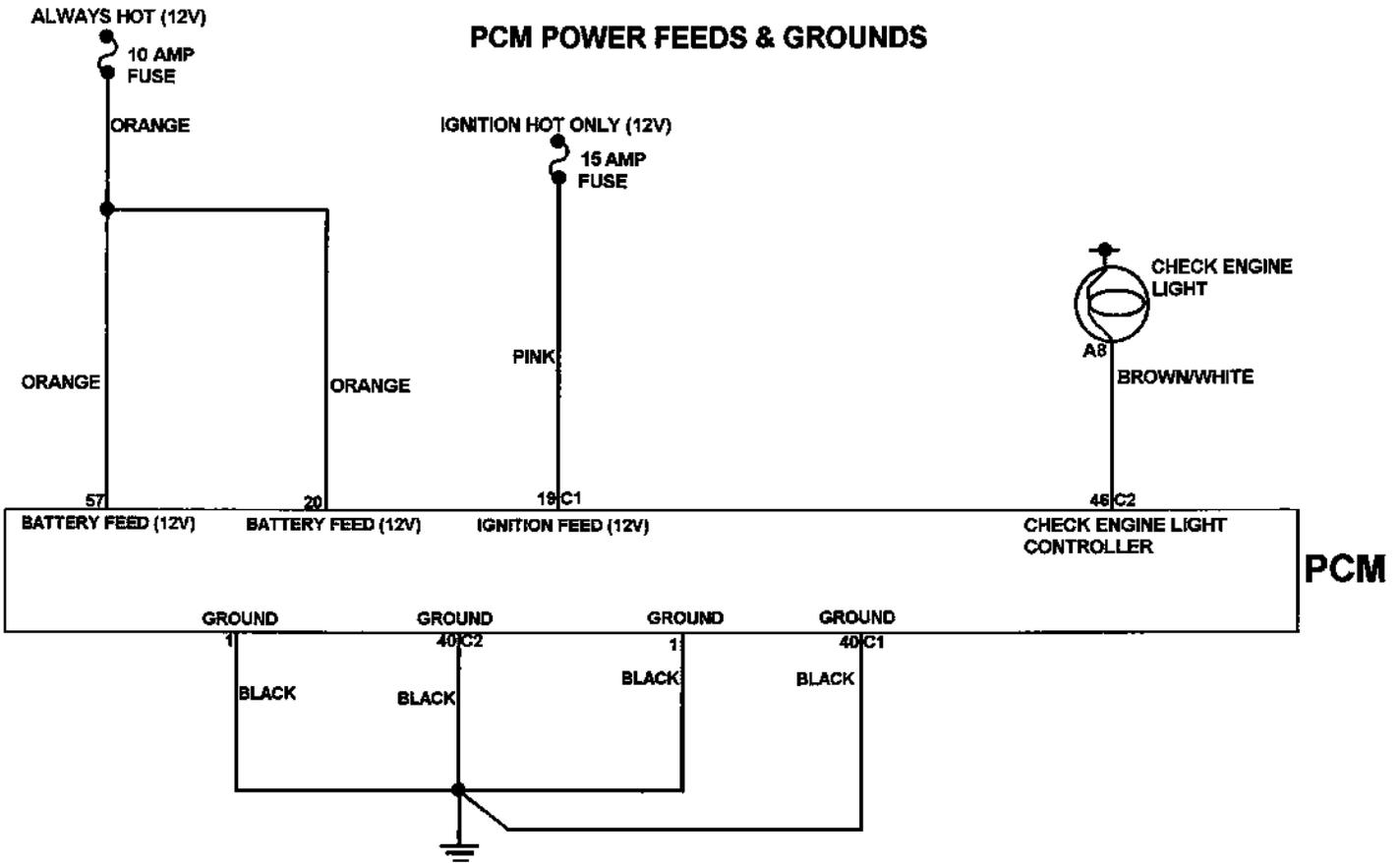

DIAGNOSTIC LINK CONNECTOR WIRING

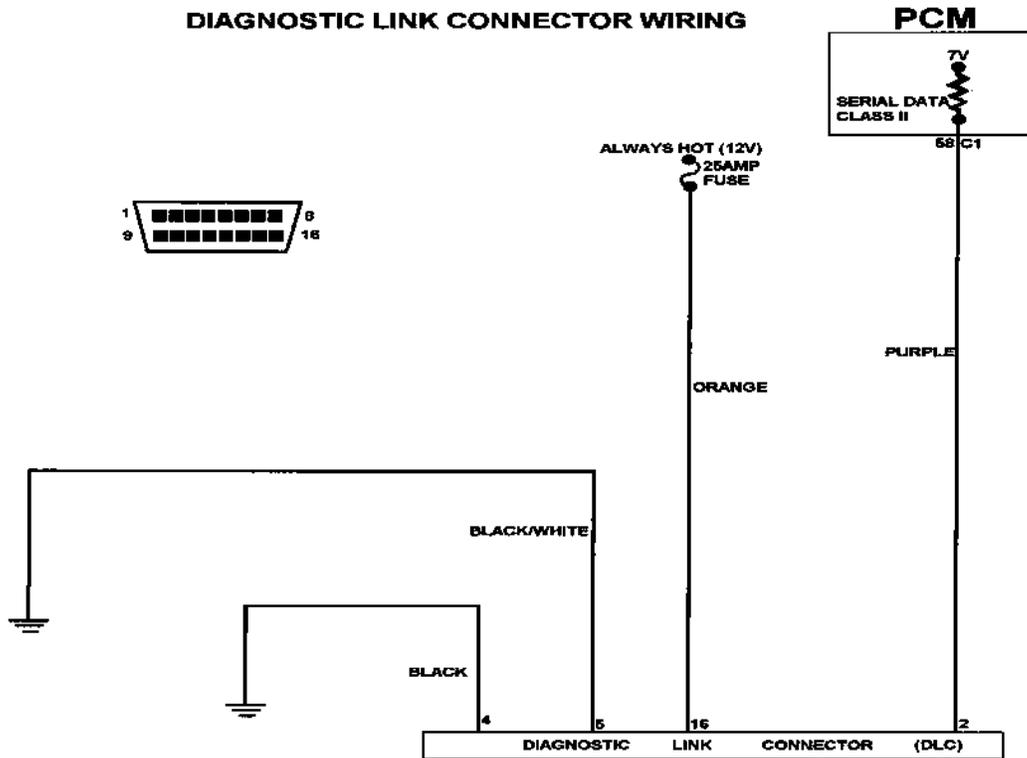

TACHOMETER + CRANKSHAFT + CAMSHAFT POSITION SENSORS

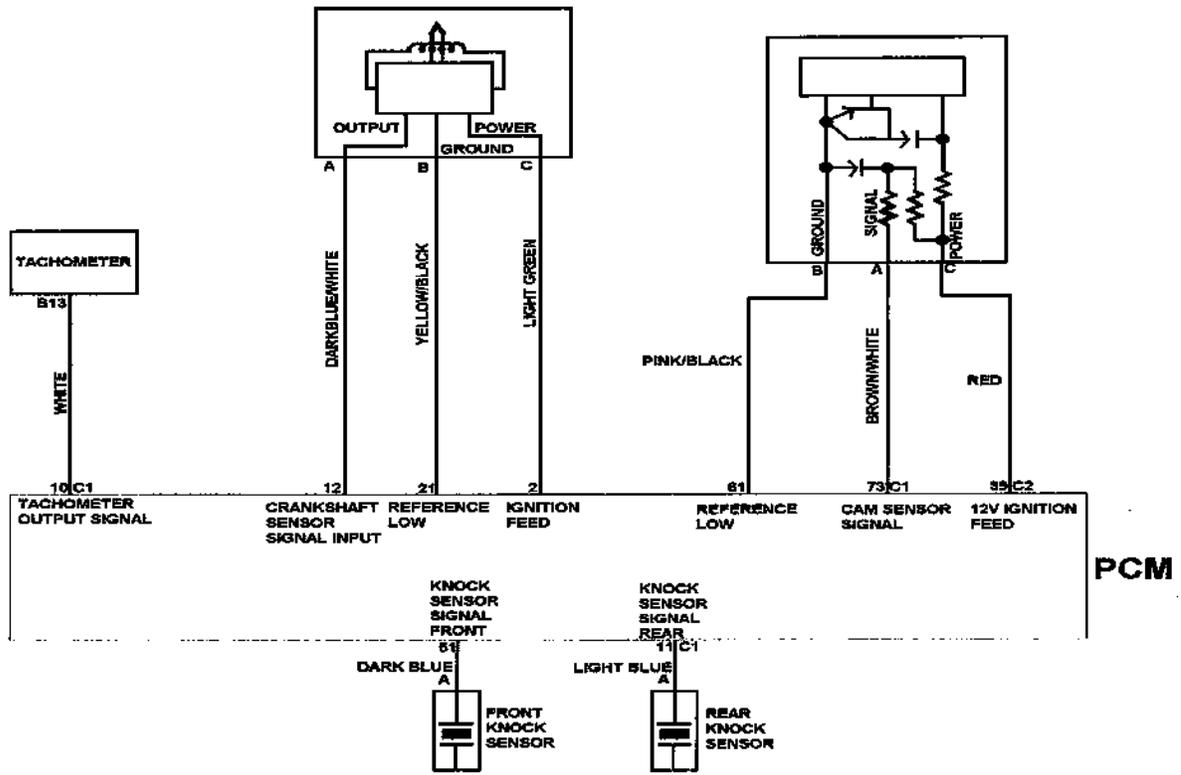

3-SPEED DUEL COOLING FANS

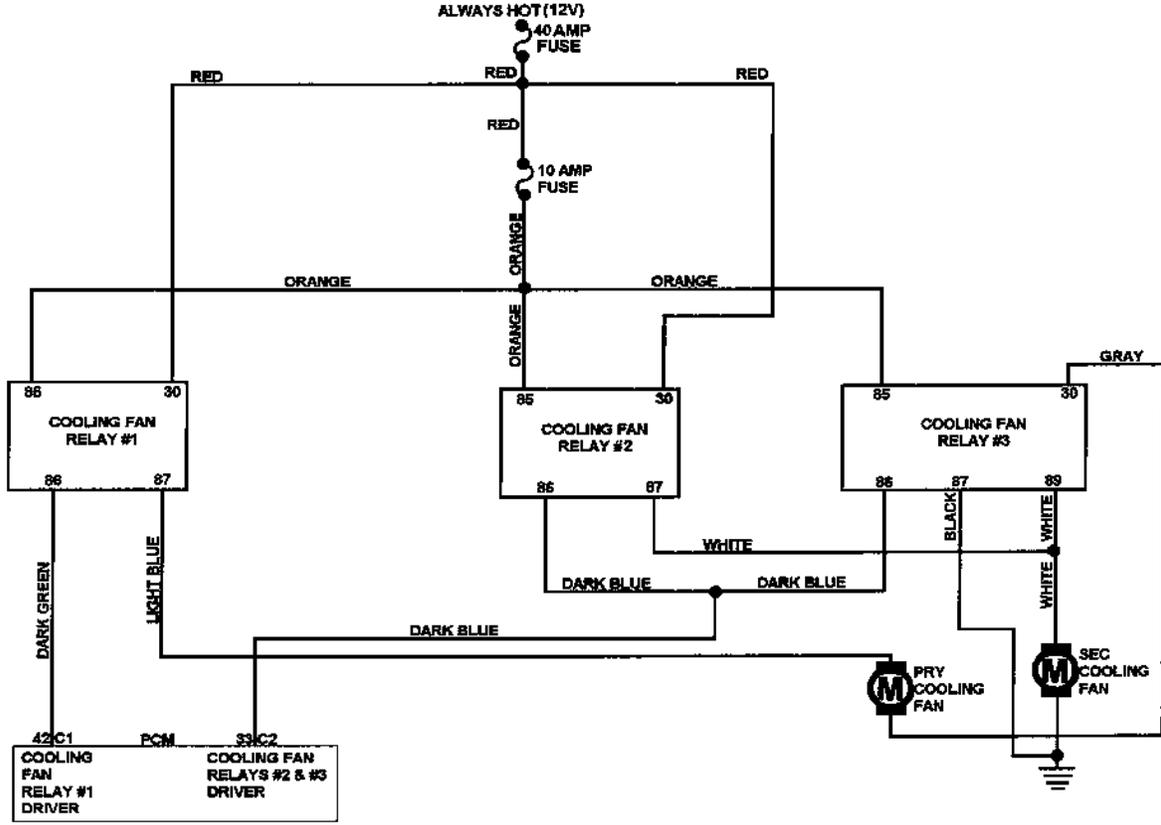

PCM'S INPUT SENSORS

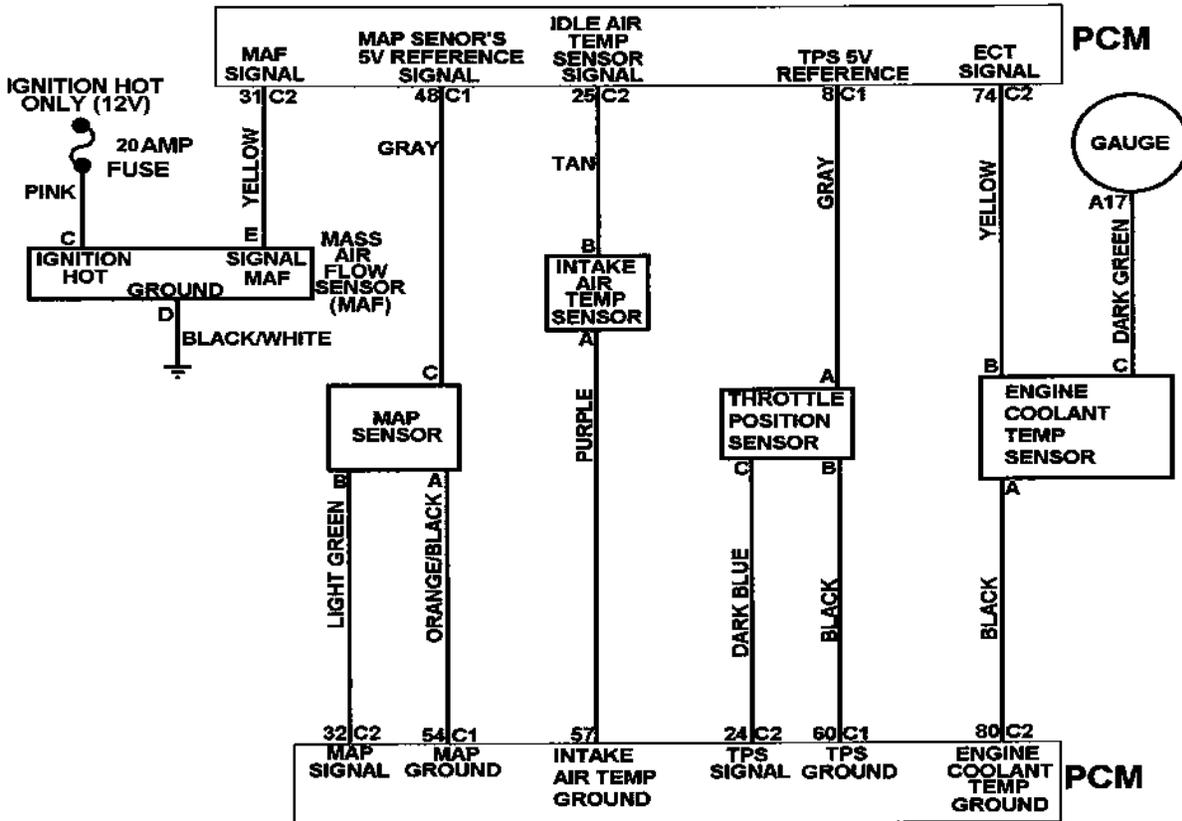

MANUAL TRANS SOLENIIDS & CLUTCH SW

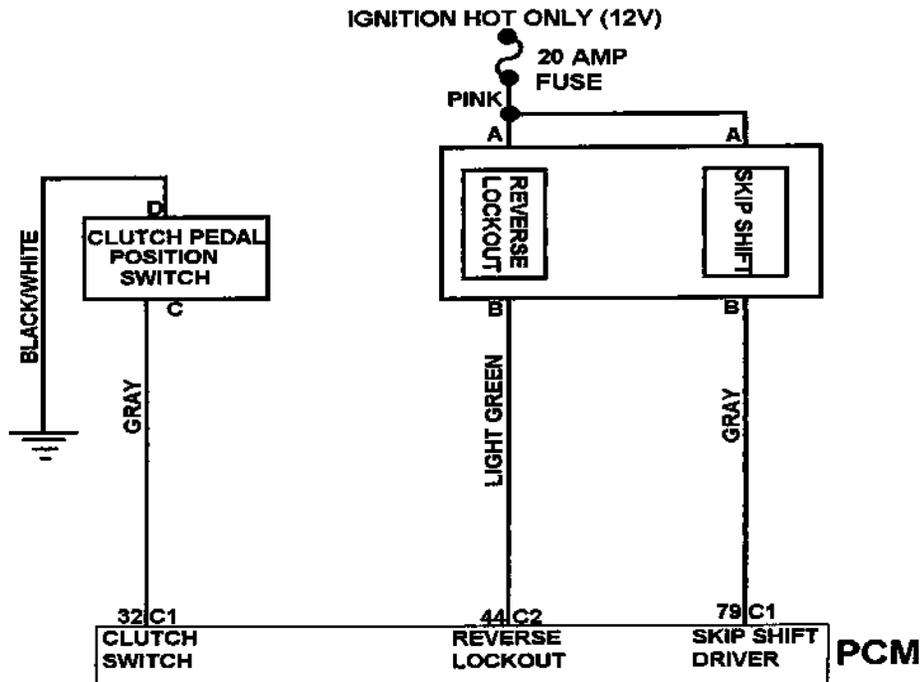

AUTOMATIC TRANSMISSION (4-SPEED) WIRING

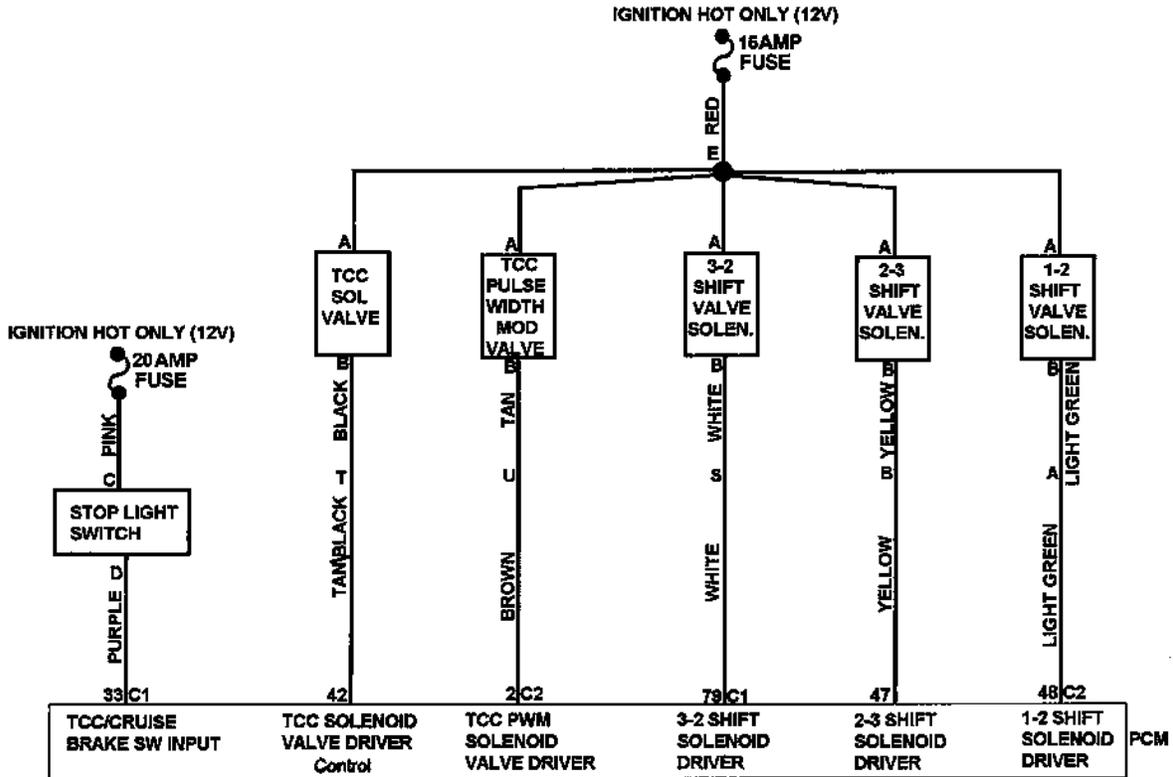

AUTOTRANS P/N & MANIFOLD SWITCHES

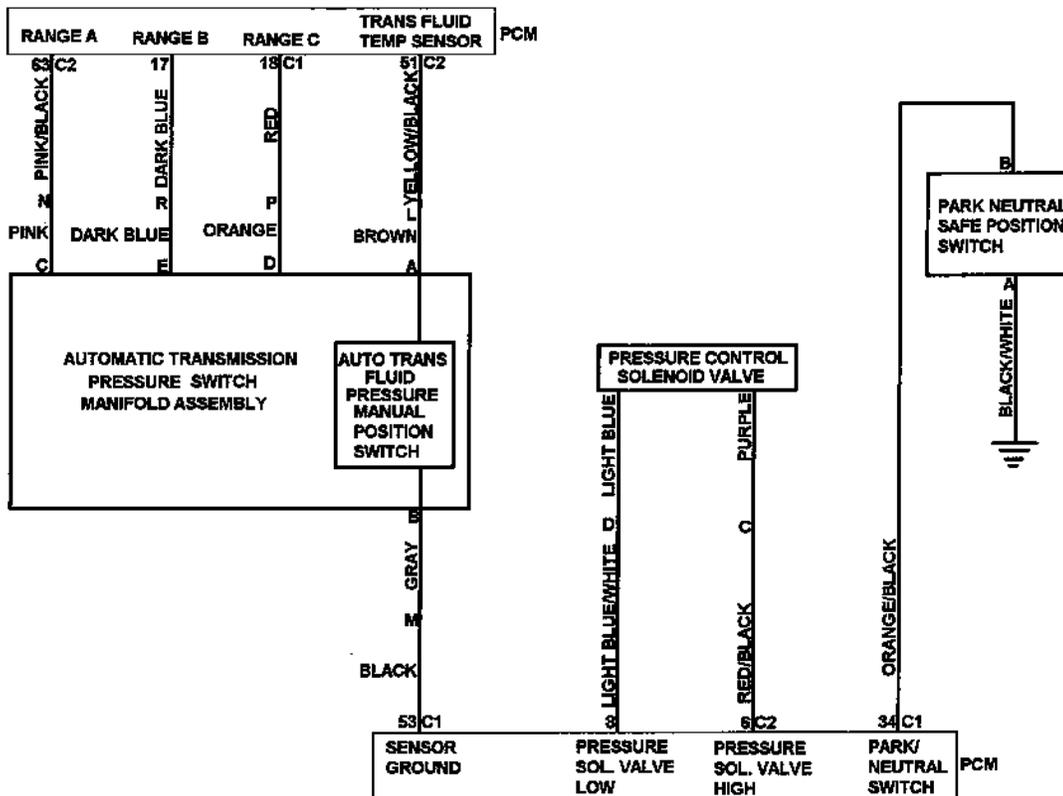

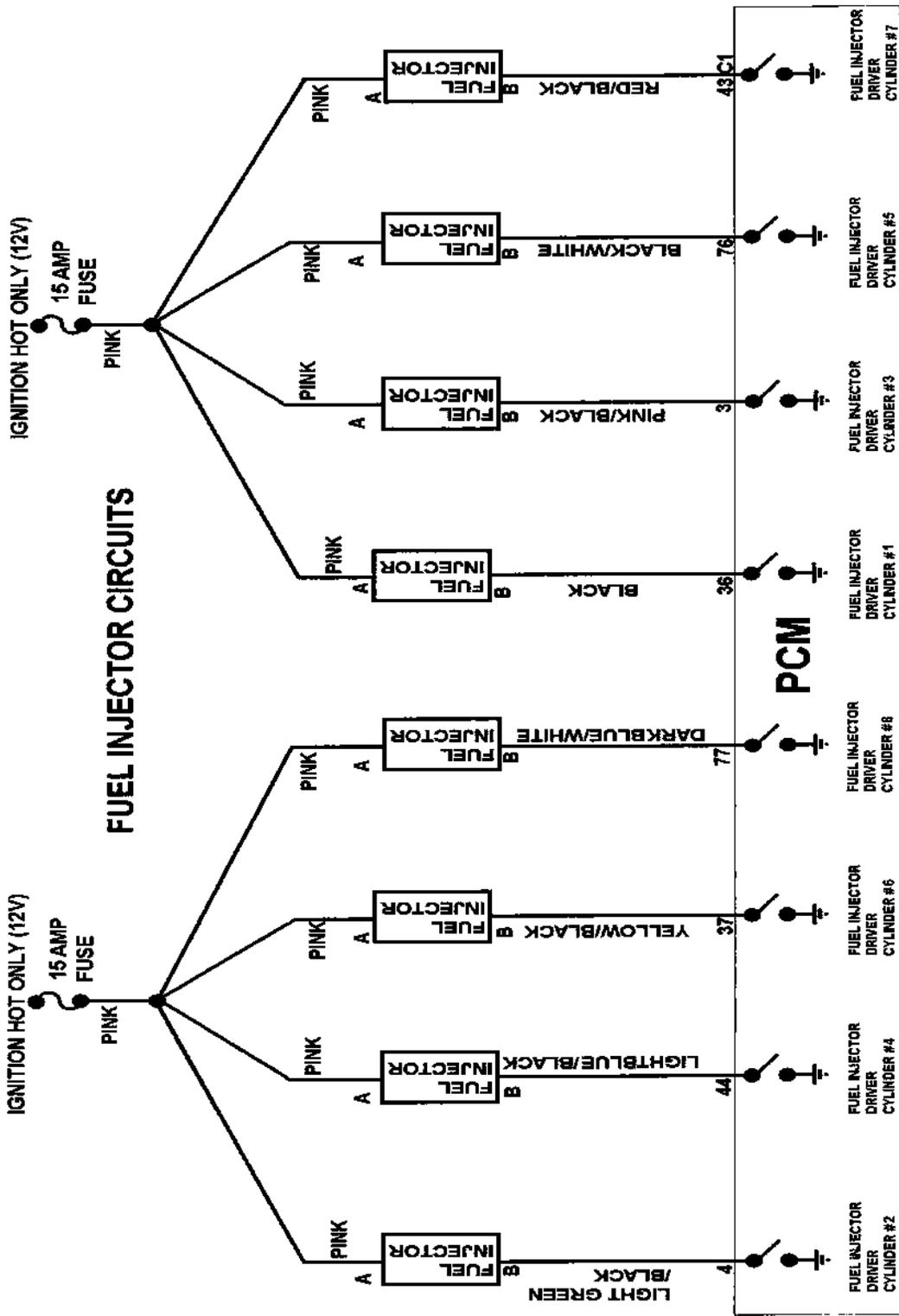

BANK 1 COILS

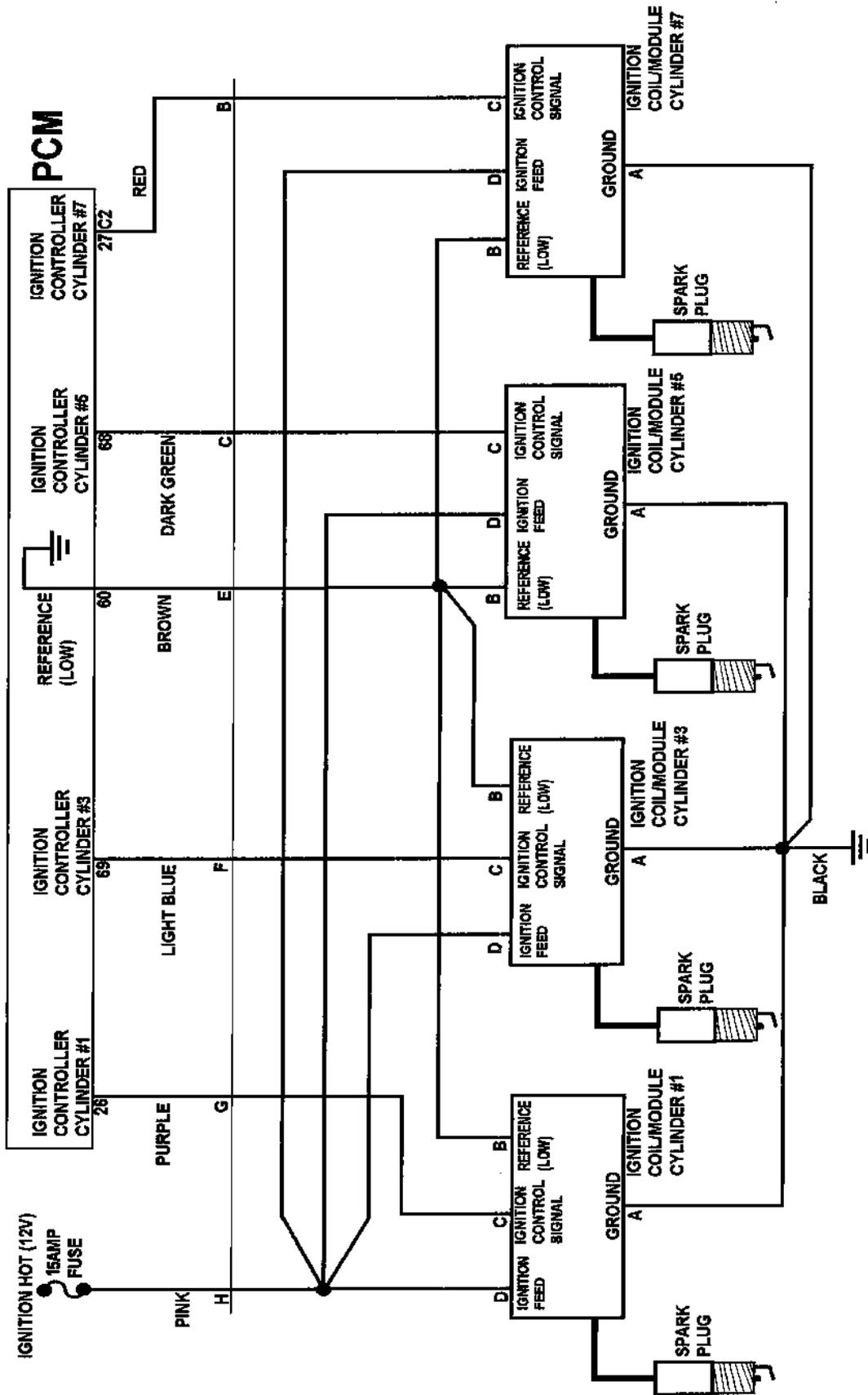

BANK 2 COILS

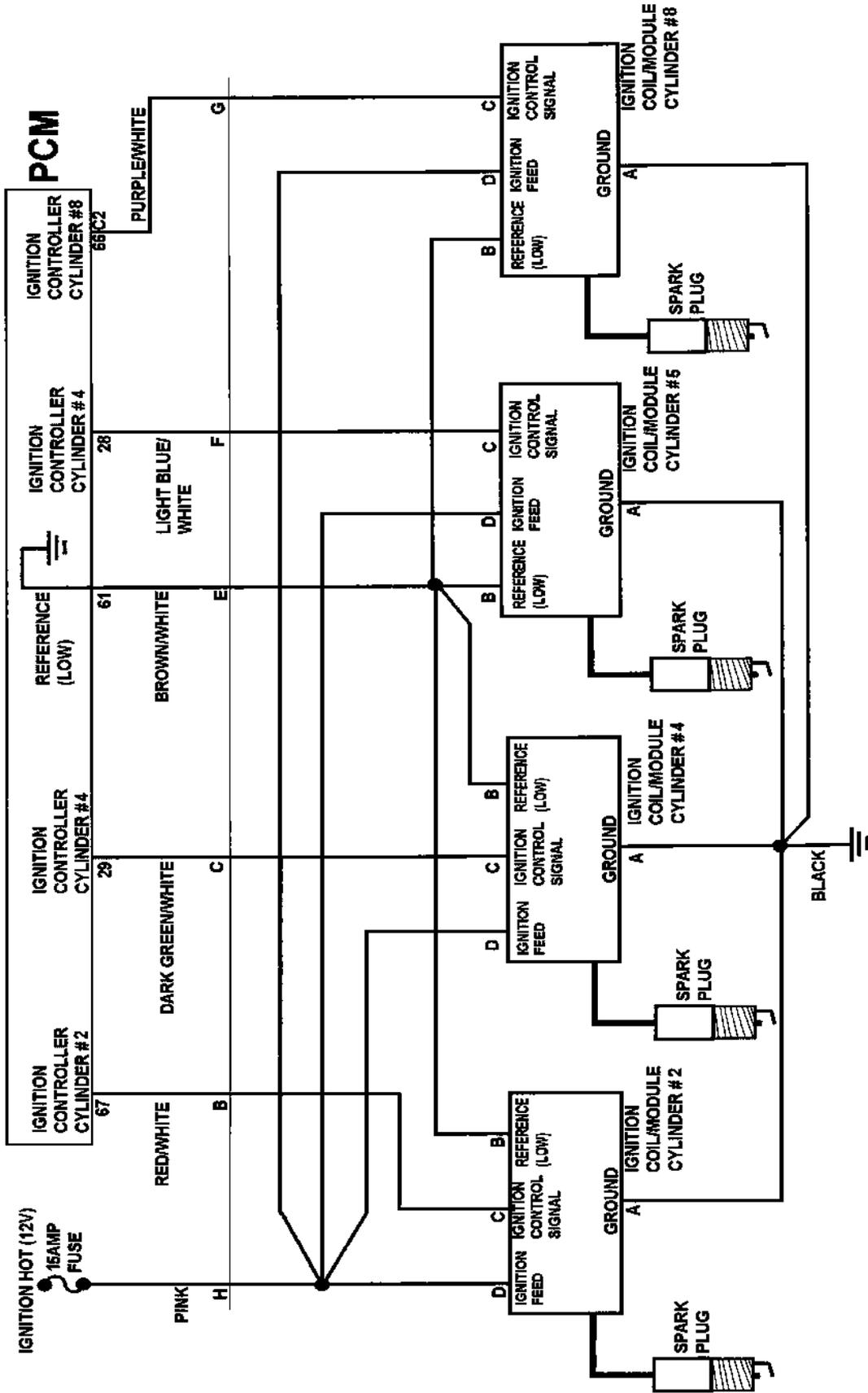

OXYGEN SENSORS (4)

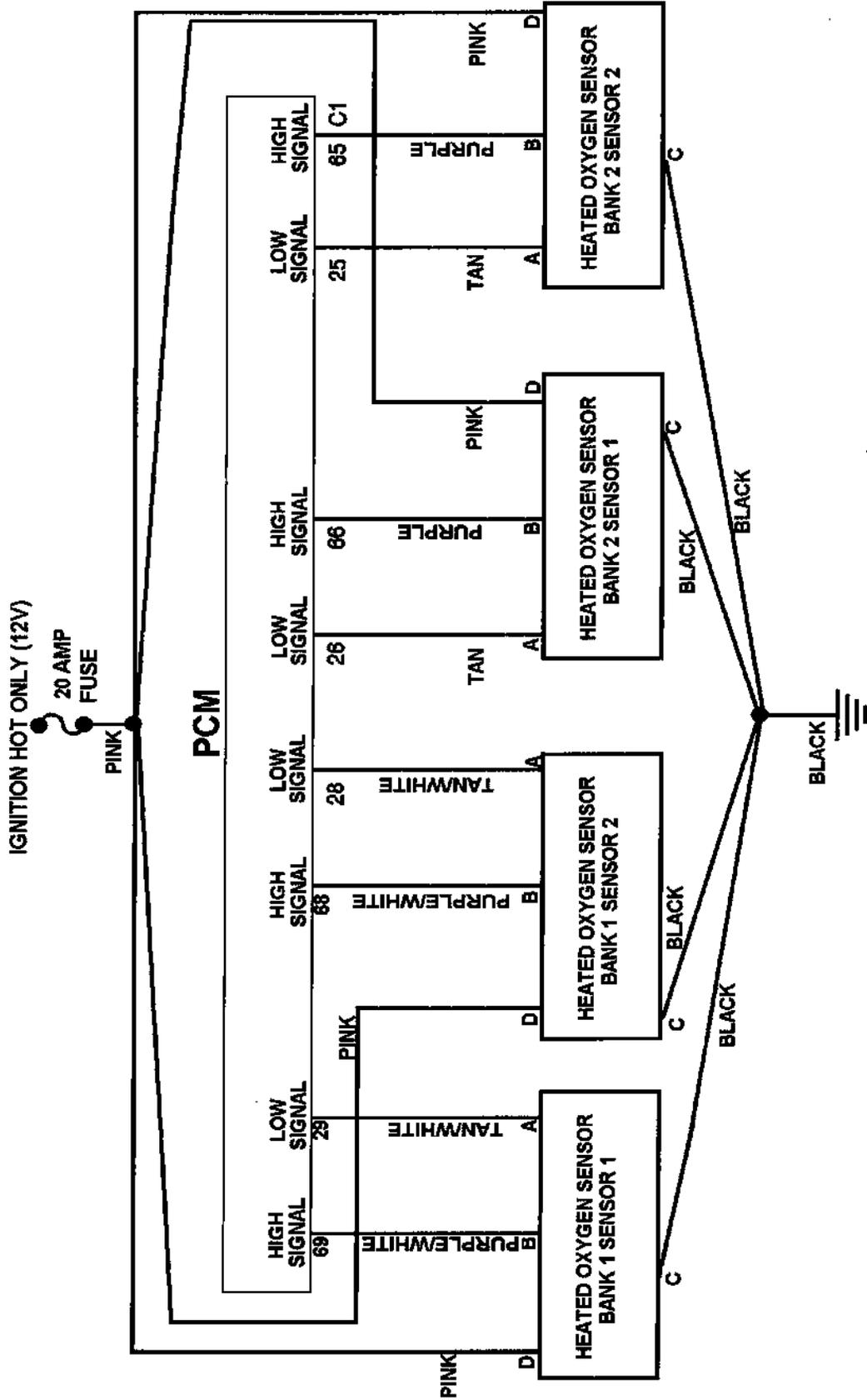

**Good Luck with your Gen III install and Setup and
Thank You for Purchasing This Handbook.**

From F-Bodies Inc

